

305
Message
Specific
Information

305 Non Settlement Estimates

305 Valid Codes

Meter Point Status

E - Energised

D - De-energised

Read Reason

01 Scheduled Read

14 Estimate

Read Type

E An estimate due to no access

EP An estimate due to a planned no-visit

EU – An estimate due to an unplanned no-visit

EF An estimate due to an implausible reading / No read available

Please Note:

Market Participant Business Reference

This is the Suppliers reference where one was provided on a 210 Supplier Provided reading and this message was sent in response (where no actual read was obtained)

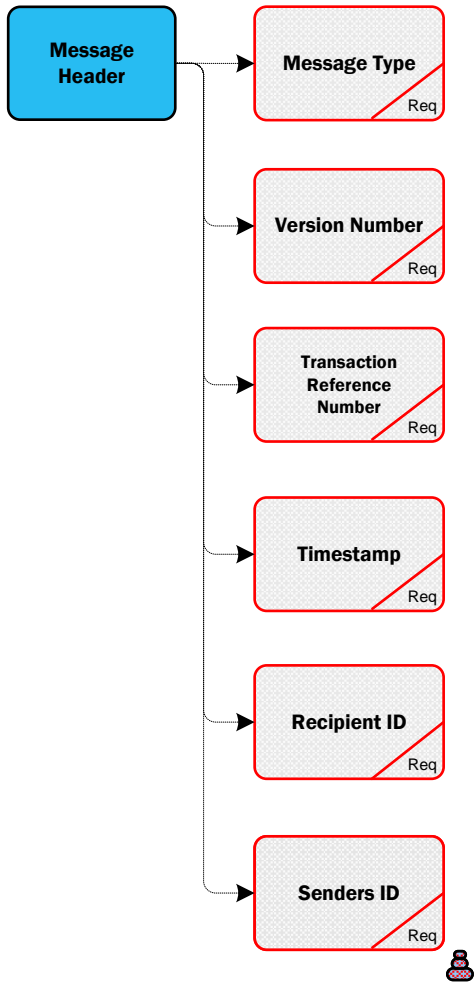

305 MPRN Level Info

MPRN

Req

Re-estimation flag

Opt

Market Participant
Business
Reference

Opt

Networks Reference
Number

Req

DUoS Group

Req



Meter Point Status

Req



Read Date

Req

No Read Code

Req



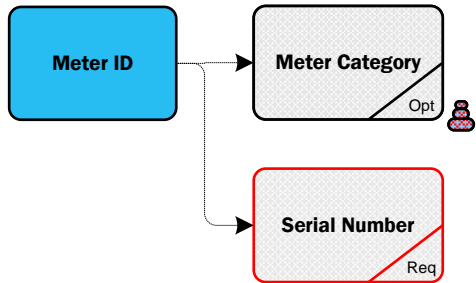



305 Register Level Info

Meter Registration Sequence
Req

Previous Read
Req

Timeslot
Req 

Consumption
Opt

Unit of Measurement
Req 

Register Type
Req 

Meter Multiplier
Req

Reading
Req

Read Reason
Req 

Read Type
Req 

**Senders
ID**

**Click Here for Latest
Senders ID
List**

305 Non Settlement Estimates

Code

DUoS Group

AGU	DG1	Urban Domestic	DG7	MV MD
AMM	DG10	Yes	DG7A	MV MD Autoproducer
CAN	DG2	Rural Domestic	DG7B	MV MD Importing Autoproducer or CHP Producer
CIP	DG3	Public Lighting	DG8	38 kV Looped MD
COL	DG4	Unmetered Supplies	DG8A	38 kV Looped MD Autoproducer
COS	DG5	LV Non-Domestic Non-MD	DG8B	38 kV Looped MD Importing Autoproducer or CHP Producer
CUG	DG5A	LV Non-Domestic Non-MD Autoproducer	DG9	38 kV Tailed MD
DIJ	DG5B	LV Non-Domestic Non-MD Importing Autoproducer or CHP Producer	DG9A	38 kV Tailed MD Autoproducer
DSO	DG6	LV MD	DG9B	38 kV Tailed MD Importing Autoproducer or CHP Producer
IA	DG6A	LV MD Autoproducer	DG10	110kV Distribution
ICD	DG6B	LV MD Importing Autoproducer or CHP Producer	TCON	Transmission Connected

Message

MPRN Level Information

RMDS RETAIL MARKET DESIGN SERVICE

DUoS Group

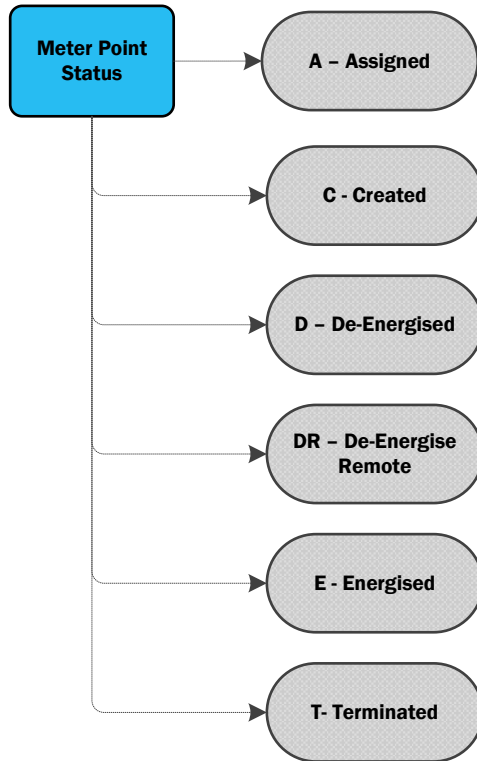

305 Non Settlement Estimates

Code

No Read Code

61 - N/A Card Not left

70 - Cannot locate meter

79 - Block Estimate - Planned

62 - N/A Card left

71 - Cannot locate premises

80 - Block Estimate - Unplanned

63 - No card possible

72 - Refused access - reasonable

97 - Estimate as of a result of implausible read

64 - Vacant - No Card left

73 - Refused access - Unreasonable

98 - Comms not available

65 - Vacant - Card left

74 - Meter in porch - locked

66 - Vacant - for sale

75 Meter hard to read

67 - Dog issue

76 - Demolished premises

68 - Meter Obstructed

77 - Derelict premises

69 - Gate locked

78 - In wrong route

Message

MPRN Level Information

RMDS

RETAIL MARKET DESIGN SERVICE

No Read Code

Meter Category

**Click Here for Latest
Meter Category
List**

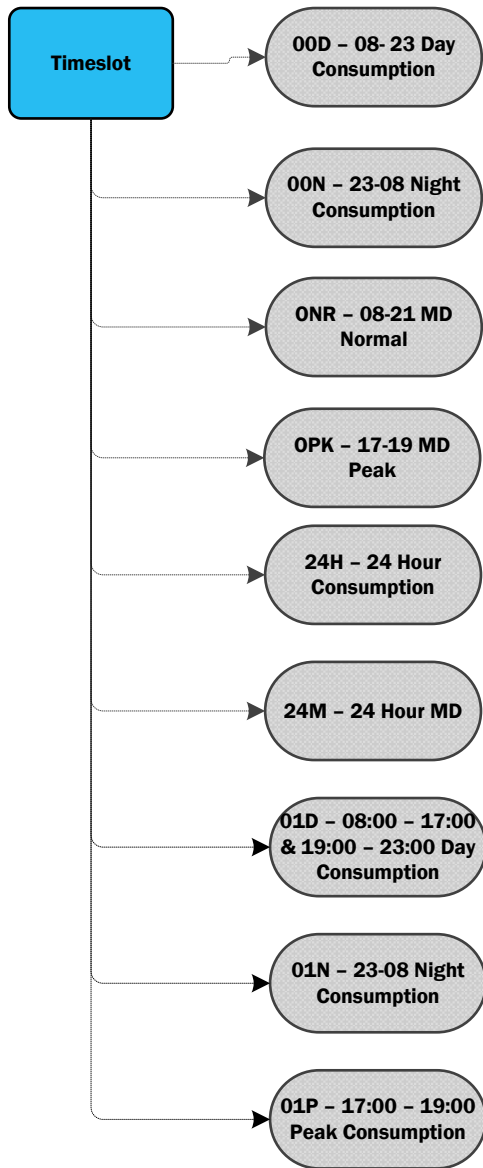

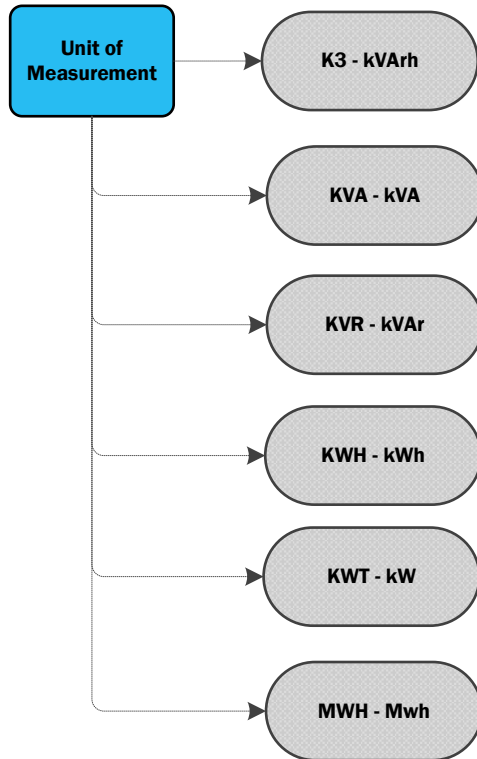

305 Non Settlement Estimates

Code

Read Reason

01 - Scheduled

17 - Change of Profile

95 - Not for CoS

02 - Special Read, Chargeable

18 - Energisation

04 - Special Read to resolve dispute

21 - Start Reading (New Register)

09 - Special Read, non chargeable

22 - Closing Reading (Register removed)

10 - Ad-hoc, no chargeable check read

23 - Meter Works Single reading

11 - Start reading after meter re-programming

26 - Change of Supplier

13 - De-Energisation

27 - Change of Legal Entity

14 - Estimate

28 - Closing read before register re-number

16 - Closing read before meter re-programming

29 - Star read after register re-number

Message

305 Register Level Info

RMDS RETAIL MARKET DESIGN SERVICE

Read Reason

305 Non Settlement Estimates

Code

Read Type

A - Actual

SU - Substitute
(Interval)

CU - Customer
Reading

E - Estimate (No
Access)

ED - Estimate (DUoS
Billing has occurred)

EF - Estimate
(Implausible/ No
Read available)

EP - Estimate (Block
Planned)

EU - Estimate (Block
Unplanned)

RC - Replacement
Read

SC - Supplier
Provided Customer
Reading

Message

305 Register
Level Info

Read Type

305 Non Settlement Estimates

Segment

Register Type

01 - 24hr

50 - IMP QH (KW)

80 - Peak

02 - Day

51 - IMP QH (kVAr)

03 - Night

52 - EXP QH(KW)

04 - NSH

53 - EXP QH (kVAr)

05 - Wattless

53 - EXP QH (kVAr)

06 - MD Normal

70 - Import HH kW

07 - MD Peak

74 - Import 24hr kWh

08 - Cumulative MD Normal

78 - Day Off Peak

09 - Cumulative MD Peak

79 - Night Off Peak

Message

305 Register Level Info

RMDS RETAIL MARKET DESIGN SERVICE

Register Type

305 Non Settlement Estimates

Version Which Implemented	Source of Change	Description of Change
10.4	MCR 1155	Message format changed from ARIS to Document format.
10.6	CoBLCR 008 & CoBLCR 011	Meter Category - Removed table & replaced with link to Meter Category page on RMDS Website
13.0	MCR 1157	Added New codes for Register Type & Timeslot
14.0	MCR1216	New meter point status for Remote De-Energise