

DUoS, Transaction and PSO Payment Process

Date of Issue: 04/12/2024
Version: 3.1

Document Updates		
Date	Description	Version
23.04.2004	<i>Issued to Market Participants for consultation</i>	1.0
29.09.2004	Revised version	1.1
04.12.2015	Revised Version – Incorporates changes related to MCR 1150	1.2
16.02.2021	Revised Version as part of Schema Release V13.0 (Smart) MCR 1157 – Smart Metering Data Processing and Data Aggregation Revised Version to include PSO Invoicing for Commercial Storage: MCR1205 – Application of the PSO to Commercial Storage	2.0
31.03.2023	MCR1223 Peak ToU for DG7 to DG9 MCR1230 Amendments to PSO process to facilitate PSO Payments Update to Scenario 1 DUoS Invoicing, Payments and Disputes to include MCR1157	3.0
04/12/2024	Revised Version – Incorporates changes as part of Minor Market ReleaseV14.2 Header alignment of section 5.5 Removal of extra commas in Table 7.2 Correction of word in Table 7.3	3.1

Table of Contents

1. Purpose of the Document	6
2. Summary	7
3. The DUoS Invoicing, Payment and Disputes Process	8
3.1 Overview of process	8
3.2 Invoicing	8
3.3 DUoS Payments	9
3.4 DUoS Disputes	10
3.4.1 Non Designated Disputes	10
3.4.2 Designated Disputes	11
4. The Transaction Invoicing, Payment and Disputes Process	12
4.1 Overview of process	12
4.2 Invoicing	12
4.3 Transaction Payments	13
4.4 Transaction Disputes	14
4.4.1 Non-Designated Disputes	14
4.4.2 Designated Disputes	15
5. The PSO Invoicing, Payment and Disputes Process	16
5.1 Overview of process	16
5.2 Invoicing	16
5.3 Payment of PSO invoice by the suppliers	17
5.4 PSO Payments from ESB Networks to suppliers	17
5.5 PSO Disputes	17
5.6 Application of the PSO levy for Commercial Storage	18
6. DUoS Invoicing, Payments and Disputes – Documentation	19
6.1 Overview	19
6.2 Scenario One	20
6.3 Scenario Two	21
6.4 Scenario Three	22
6.5 Scenario Four	23
6.6 Scenario Five	24
6.7 Scenario Six	
6.8 DUoS Exhibits	25
7 Transaction Invoicing, Payments and Disputes – Documentation	74
7.1 Overview	74
7.2 Scenario One	75
7.3 Scenario Two	76
7.4 Scenario Three	77
7.5 Scenario Four	78
7.6 Transaction Exhibits	79
8 PSO Invoicing, Payments and Disputes - Documentation	115
8.1 Overview	115
8.2 Scenario One	116
8.3 Scenario Two	117
8.4 Scenario Three	117
8.5 PSO Exhibits	118
Exhibit ID: P3.1	125
9 DUoS/Transaction/PSO Flat File Formats	126
9.1 Introduction	126
9.2 File Data Formats	127
9.2.1 MPRN Level Invoice Item Detail – Flat File	127

9.2.2 Detailed Transaction Charges – Flat File 134
9.2.3 PSO Invoice Detailed Backing Documentation – Flat File 138
9.2.4 PSO Adjustment Invoice Detailed Backing Documentation - Flat File 141
9.2.5 Dispute Detail – Flat File 144

1. Purpose of the Document

The purpose of this document is to communicate to market participants the processes and detailed documentation surrounding invoicing, payment and disputes associated with:

- DUoS charges
- Transaction charges for services carried out on behalf of the Supplier
- Application of the PSO Levy or Payment .

This document should be read in conjunction with :

- **MPD 34 – DUoS, Transaction and PSO Payment Process**
- **Market Message Implementation Guide – DUoS and Transaction Payments**
- **Supplier Communications Resulting from DUoS Billing and Invoicing**
- **Distribution Use of System Agreement – Framework Agreement –**
Approved by CRU on 9th November 2009
- **PSO Invoicing and Collection Procedures**
- **WP0029 Procedure for Application of the PSO Levy for Commercial Storage**

2. Summary

Sections three to five describe the invoicing, payment and disputes processes for DUoS, Transaction and PSO rates. . The associated documentation is introduced and explained.

Sections six to eight illustrate how the documentation should be interpreted through the use of sample business scenarios.

Section nine describes the format and content of DUoS, Transaction and PSO backing documentation.

3. The DUoS Invoicing, Payment and Disputes Process

3.1 Overview of process

ESB Networks invoices Suppliers twice a month for DUoS charges, mid-month and at month end. ESB Networks sends an invoice to the Supplier along with backing documentation, which allows the Supplier to validate the amount due. The Supplier makes payment via an EFT and sends a 507C control market message and remittance advice to ESB Networks to facilitate the processing of the payment.

The following sections describe the process and documentation relating to Supplier DUoS invoicing in more detail.

3.2 Invoicing

Individual MPRNs registered with the Supplier are invoiced at various points during the billing period. These individual invoice items are aggregated and a single DUoS invoice is created for the Supplier. This process is described in greater detail in *Supplier Communications Resulting from DUoS Billing and Invoicing*, section 3.

The documentation created at each instance of invoicing is as follows:

- Invoice *
- Credit Note *
- DUoS Group Summary *
- MPRN Level Invoice Items Detail **
- Account Statement *
- Dispute Summary *
- Dispute Detail **
- Remittance Advice ***

* PDF format.

** Flat file format.

*** MS Excel file.

This information is sent to the Supplier via the Secure File Transfer Service (SFTS) or Encrypted Email (EE).

Each of these documents will be briefly explained below. Section 6 illustrates how each document should be interpreted using a number of invoicing scenarios.

Invoice

This is a VAT document that indicates the amount relating to MPRNs billed in the period since the previous invoice (referred to as charges for current billing period). Where applicable, a second line on the invoice includes re-invoiced amounts for MPRNs billed in previous periods, but subsequently reversed (referred to as adjustment debit charges). These re-invoiced amounts can arise out of Supplier disputes or can be triggered by other processes within ESB Networks.

VAT is calculated and shown separately for each of the two lines.

The document indicates the due date, which is calculated in accordance with the *Distribution Use of System Agreement*.

Credit Note

The credit note includes reversals of MPRN amounts charged in previous invoices (referred to as adjustment credit charges). These reversals can arise out of Supplier disputes or can be triggered by other processes within ESB Networks. The associated VAT is shown on a separate line.

DUoS Group Summary

This report shows an analysis of the net invoice and credit note amounts by DUoS group, split between the component charges i.e. day energy consumption, night energy consumption etc.

MPRN Level Invoice Items Detail

This flat file contains line items at MPRN level, also referred to as invoice items. The gross amount for each invoice item is shown. This gross amount is relevant when disputing invoice items (refer to section 3.4.2). Section 9 describes the format and content of this flat file in detail. See also Section 7 of the *Supplier Communications Resulting from DUoS Billing and Invoicing*, which provides a comprehensive guide to interpreting the data contained in this flat file.

Account Statement

This report shows all movements on the Supplier's account since the previous statement i.e. opening balance brought forward, payments received from the Supplier during the period, invoices and credit notes issued by ESB Networks during the period and the resulting closing balance on the Supplier account.

The amount due from the Supplier is calculated as the above closing balance less any designated disputes in progress. Designated disputes are discussed in detail in section 3.4.2.

Dispute Summary

This report shows, by invoice, the status (e.g. in progress, accepted, denied) and gross value of disputes.

Dispute Detail

This flat file supports the dispute summary. It contains each disputed invoice item. Section 9 describes the format and content of this flat file in detail.

Remittance Advice

This spreadsheet reflects the amount due as per the account statement i.e. the current invoice and resolved designated disputes from previous invoices. The Supplier completes this document by inserting the 507C control message amount (refer to section 3.3) applicable to the current invoice, which automatically calculates the EFT amount. The Supplier returns the advice to ESB Networks to facilitate the processing of the payment against the appropriate invoice items.

3.3 DUoS Payments

Upon receipt of the documents via SFTS / EE, the Supplier:

- Validates the amount due to ESB Networks using the documentation received via SFTS / EE.
- Submits a 507C control market message confirming the gross amount and number of designated disputes raised on the current invoice. The purpose of the 507C message is to facilitate the allocation of the Supplier's payment against the current invoice. **Therefore it is**

important that the Supplier always sends a 507C message whether they have raised designated disputes or not.

- Completes the remittance advice by inserting the 507C control message amount and returns it to ESB Networks.
- Pays the amount due as per the remittance advice via EFT by the due date. This due date is as defined in the *Distribution Use of System Agreement*.

3.4 DUoS Disputes

As discussed above, the Supplier validates the amount due using the documentation received via SFTS / EE from ESB Networks. As part of this process, the Supplier may dispute invoice items on the current invoice.

A Supplier may raise two types of disputes:

- Non Designated Disputes
- Designated Disputes

Designated disputes are defined in the *Distribution Use of System Agreement* as occurring when:

- there is an error in the information used for the calculation or an arithmetic error in the calculation of Use of System Charges by the Company which is apparent on the face of the account and/or
- the Company chooses not to use the half-hourly data (whether actual or estimated) for the purposes of Settlement in calculating Use of System Charges and the User disputes the accuracy or validity of the data actually used.

All other disputes are termed non-designated.

3.4.1 Non Designated Disputes

Disputes raised for reasons other than those included in section 3.4 are termed non-designated.

The Supplier raises a non-designated dispute in a timeframe in accordance with the *Distribution Use of System Agreement*.

These disputes are communicated offline to the designated office as specified on the DUoS invoice.

The Supplier must make a payment for the amount under dispute by the due date in accordance with the *Distribution Use of System Agreement* i.e. the Supplier cannot withhold payment for a non-designated dispute.

Non-designated disputes will be resolved in a timeframe in accordance with the *Distribution Use of System Agreement*. ESB Networks will close the dispute only after confirming the resolution with the Supplier.

In the case of an accepted non-designated dispute, the original invoice item will be reversed and re-billed if necessary. These adjustments will be included in the subsequent invoice and credit note issued by ESB Networks. All other documentation issued via SFTS / EE will also reflect the reversed and re-billed amounts. For further information on billing reversals, refer to *Supplier Communications Resulting from DUoS Billing and Invoicing*, section 5.7

A denied non-designated dispute will have no impact on the next invoice/credit note and associated documentation as the item has been paid and no billing adjustment is required.

3.4.2 Designated Disputes

The Supplier raises designated disputes in a timeframe in accordance with the *Distribution Use of System Agreement*.

The Supplier notifies ESB Networks of designated disputes by sending a 507 Market Message for each disputed invoice item. When all designated disputes have been raised for an invoice, the Supplier sends a 507C control Market Message to EBS Networks confirming the total gross amount and number of all designated disputes raised on the current invoice. The *Market Message Implementation Guide – DUoS and Transaction Payments* contains instructions for sending 507 and 507C messages.

The Supplier withholds payment of the total amount of the disputed invoice items as reflected in the 507C control message. The gross amount for each invoice item is available in the *MPRN Level Invoice Item Detail* flat file.

Designated disputes will be resolved in a timeframe in accordance with the *Distribution Use of System Agreement*. EBS Networks will close the dispute only after confirming the resolution with the Supplier.

Upon resolution, designated disputes become due for payment in accordance with the *Distribution Use of System Agreement*. In the case of an accepted designated dispute, the next invoice and credit note that issue will include a reversal of the original disputed invoice item and a re-invoiced amount, where appropriate.

The original gross amount of a denied designated dispute is due for payment.

4. The Transaction Invoicing, Payment and Disputes Process

4.1 Overview of process

ESB Networks invoices Suppliers at month end, for transactions carried out for that Supplier during the month.

ESB Networks sends an invoice to the Supplier along with backing documentation, which allows the Supplier to validate the amount due. The Supplier pays the amount due via an EFT and sends a 507C control market message and remittance advice to ESB Networks to facilitate the processing of the payment.

The following sections describe the process and documentation relating to transaction charges in more detail.

4.2 Invoicing

The documentation created at each instance of invoicing is as follows:

- Invoice *
- Credit Note *
- Detailed Transaction Charges (debit charges)**
- Detailed Transaction Charges (credit charges)**
- Account Statement *
- Dispute Summary *
- Dispute Detail **
- Remittance Advice ***

* PDF format.

** Flat file format.

*** MS Excel file.

This information is sent to the Supplier via SFTS / EE.

Each of these documents will be briefly explained below. Section 7 illustrates how each document should be interpreted using a number of invoicing scenarios.

Invoice

This is a VAT document that indicates the total charge for transactions carried out for the Supplier during the month. The associated VAT is shown on a separate line.

The document indicates the due date, which is calculated in accordance with the *Distribution Use of System Agreement*.

Credit Note

The credit note is a VAT document which shows reversals of transaction charges included in previous invoices. The reversals are split on the face of the credit note as follows - credits for unpaid invoice items (i.e. accepted designated disputes) and credits for paid invoice items (i.e. accepted non-designated disputes and other reversals). The associated VAT for each type is shown separately.

Detailed Transaction Charges

This flat file contains line items for each transaction, referred to as invoice items. Separate flat files are created for both invoice and credit note. The gross amount is relevant when disputing invoice items (refer to section 4.4.2). Section 9 describes the format and content of this flat file in detail.

Account Statement

This report shows all movements on the Supplier's account since the previous statement i.e. opening balance brought forward, payments received from the Supplier during the period, invoices and credit notes issued by ESB Networks during the period and the resulting closing balance on the Supplier account.

The amount due from the Supplier is shown as the above closing balance less any designated disputes in progress. Designated disputes will be discussed in detail in section 4.4.2 below.

Dispute Summary

This report shows, by invoice, the status (e.g. in progress, accepted, denied) and gross value of disputes.

Dispute Detail

This flat file supports the dispute summary. Section 9 describes the format and content of this flat file in detail.

Remittance Advice

This spreadsheet reflects the amount due as per the account statement, which includes the current invoice, credits for previously paid invoice items now reversed and unpaid denied designated disputes from previous invoices. The Supplier completes this document by inserting the 507C control message amount (refer to section 4.3) applicable to the current invoice, which automatically calculates the EFT amount. The Supplier returns the advice to ESB Networks to facilitate the processing of the payment against the appropriate invoice items.

4.3 Transaction Payments

Upon receipt of the documentation via SFTS / EE, the Supplier:

- Validates the amount due to ESB Networks using the documentation received via SFTS / EE.
- Submits a 507C control message confirming the gross amount and number of designated disputes raised on the current invoice. The purpose of the 507C message is to facilitate the allocation of the Supplier's payment against the current invoice. **Therefore it is important that the Supplier always sends a 507C message whether they have raised designated disputes or not.**
- Completes the remittance advice by inserting the 507C control message amount and returns it to ESB Networks.
- Pays the amount due as per the remittance advice via EFT on the due date. This due date is as per the *Distribution Use of System Agreement*.

4.4 Transaction Disputes

As discussed above, the Supplier validates the amount due using the documentation received via SFTS / EE from ESB Networks. As part of this process, the Supplier may dispute invoice items on the current invoice.

A Supplier may raise two types of disputes:

- Non Designated Disputes
- Designated Disputes

Designated disputes are defined in the *Distribution Use of System Agreement* as occurring when:

- there is an error in the information used for the calculation or an arithmetic error in the calculation of Use of System Charges by the Company which is apparent on the face of the account and/or
- the Company chooses not to use the half-hourly data (whether actual or estimated) for the purposes of Settlement in calculating Use of System Charges and the User disputes the accuracy or validity of the data actually used.

All other dispute reasons are termed non-designated.

4.4.1 Non-Designated Disputes

Disputes raised for reasons other than those included in section 4.4 are termed non-designated.

The Supplier raises a non-designated dispute in a timeframe in accordance with the *Distribution Use of System Agreement*.

These disputes are communicated offline to the designated office as specified on the Transaction invoice.

The Supplier must make a payment for the amounts under dispute by the due date in accordance with the *Distribution Use of System Agreement* i.e. the Supplier cannot withhold payment for a non-designated dispute.

Non-designated disputes will be resolved in a timeframe in accordance with the *Distribution Use of System Agreement*. ESB Networks will close the dispute only after confirming the resolution with the Supplier.

In the case of an accepted non-designated dispute, the original invoice item will be reversed and re-billed if necessary. These adjustments will be included in the subsequent invoice and credit note issued by ESB Networks. All other documentation issued via SFTS / EE will also reflect the reversed and re-invoiced amounts.

A denied non-designated dispute will have no impact on the next invoice/credit note and associated documentation as the item has been paid and no adjustment is required.

4.4.2 Designated Disputes

The Supplier raises designated disputes in a timeframe in accordance with the *Distribution Use of System Agreement*.

The Supplier notifies ESB Networks of designated disputes by sending a 507 Market Message for each disputed invoice item. When all designated disputes have been raised for an invoice, the Supplier sends a 507C control Market Message to EBS Networks indicating the gross amount and number of all designated disputes raised on the current invoice. The *Market Message Implementation Guide – DUoS and Transaction Payments* contains instructions for sending 507 and 507C messages.

The Supplier withholds payment of the total amount of the disputed invoice items as reflected in the 507C control message. The gross amount for each invoice item is included in the *Detailed Transaction Charges* flat file.

Designated disputes will be resolved in a timeframe in accordance with the *Distribution Use of System Agreement*. EBS Networks will close the dispute only after confirming the resolution with the Supplier.

Upon resolution, designated disputes become due for payment in accordance with the *Distribution Use of System Agreement*. In the case of an accepted dispute, the next invoice and credit note that issue will include a reversal of the original disputed invoice item and a re-invoiced amount, where appropriate. The original gross amount of a denied designated dispute is due for payment.

5. The PSO Invoicing, Payment and Disputes Process

5.1 Overview of process

The PSO rate, be it PSO Levy or PSO Payment, is set by CRU. This results in ESB Networks invoicing or crediting a supplier on a monthly basis for the applicable PSO rate based on customers connected to the Distribution network and registered with that Supplier at the month end (in accordance with the CRU *PSO Invoicing and Collection Procedures*).

ESB Networks sends an invoice to the Supplier along with backing documentation. A credit note will issue where amounts are due to the supplier in relation to previous PSO periods. The Supplier makes full payment for any invoiced amount due via an EFT.

The following sections describe the process and documentation relating to PSO charges in more detail.

5.2 Invoicing

The documentation created at each instance of invoicing is as follows:

- PSO Invoice *
- PSO Adjustment Invoice *
- Detailed Backing Documentation **
- Adjustment Detailed Backing Documentation **
- Credit Note***

* PDF format

** Flat file format

***Will only issue when a credit is due to a supplier in relation to previous PSO periods.

This information is sent to the Supplier via SFTS / EE.

Each of these documents will be briefly explained below. Section 8 illustrates how each document should be interpreted using a number of invoicing scenarios.

PSO Invoice

This document is a VAT invoice that indicates the PSO Levy applicable to the Supplier for the month, per PSO category. The associated VAT is shown on a separate line.

The document indicates the due date, which is calculated in accordance with the *PSO Invoicing and Collection Procedures*.

PSO Adjustment Invoice

ESB Networks reviews a rolling four month history of PSO charges/payments at each month end. Any retrospective adjustments resulting from this review are reflected in this PSO Adjustment Invoice. The invoice indicates the adjustment charge per PSO category and per prior month.

This is also a VAT document and accordingly the associated VAT is shown on a separate line.

The document indicates the due date, which is calculated in accordance with the *PSO Invoicing and Collection Procedures*.

Detailed Backing Documentation

This flat file lists the MPRNs registered with the Supplier along with their associated PSO category. In the case of large customers (PSO3), the associated MIC is also included. Section 9 describes the format and content of this flat file in detail.

Adjustment Detailed Backing Documentation

This flat file has the same format and content as the above file. But as its purpose is to support the adjustment invoice (which retrospectively adjusts previous months' charges/payments), it also indicates whether each MPRN is an addition or reduction to the number of MPRNs registered with the Supplier. Section 9 describes the format and content of this flat file in detail.

Credit Note

The credit note is a VAT document which shows any credit due to the supplier in relation to previous PSO invoices.

The associated VAT is shown on a separate line.

5.3 Payment of PSO invoice by the suppliers

The Supplier makes full payment for the amount due via EFT by the due date. This due date is as defined in the *PSO Invoicing and Collection Procedures*. The Supplier cannot withhold payment for disputed invoice items.

5.4 PSO Payments from ESB Networks to suppliers

For PSO Payments ESB Networks makes the payment for the amount due via EFT in accordance with PSO Invoicing and Collection Procedures.

A supplier must provide bank details to ESB Networks in advance. Where a supplier requests a change of bank details at least 4 weeks' notice must be provided by the supplier to ESB Networks.

5.5 PSO Disputes

Upon receipt of the documentation via SFTS / EE , the Supplier validates the amount due to ESB Networks . As part of this process, the Supplier may dispute invoice items on the current invoice.

A Supplier may raise two types of disputes:

- Non Designated Disputes
- Designated Disputes

Designated disputes are defined in the *PSO Invoicing and Collection Procedures* as occurring when:

- there is an error in the information used for the calculation or an arithmetic error in the calculation of PSO Charge by the Company which is apparent on the face of the account and/or

All other dispute reasons are termed non-designated.

The Supplier notifies ESB Networks of disputes, whether designated or non-designated via offline communication i.e. the Supplier does not communicate designated disputes to ESB Networks via a 507 market message.

ESB Networks will resolve the dispute in a timeframe in accordance with the *PSO Invoicing and Collection Procedures*.

The Supplier cannot withhold payment of a disputed amount, whether designated or non-designated, in accordance with the *PSO Invoicing and Collection Procedures*.

5.6 Application of the PSO levy for Commercial Storage

Application of the PSO levy for Commercial Storage Sites is addressed in WP0029 Procedure of Application of PSO for Commercial Storage Sites.

6. DUoS Invoicing, Payments and Disputes – Documentation

6.1 Overview

This section illustrates the documentation that a Supplier receives from ESB Networks and the documentation that must be returned to ESB Networks over the course of a number of DUoS invoicing scenarios. The purpose of the scenarios is to illustrate how the regular cyclical invoicing and payment process will work in possible scenarios.

Six scenarios of DUoS invoicing will be demonstrated. The events occurring in each scenario will be referenced to the relevant steps in *MPD 34 – DUoS, Transaction and PSO Payment Process* and to sample formats of the relevant documentation. The Six scenarios are as follows:

Scenario	Invoice Date	Timeframe	Scenario Feature
One	19 January	19 Jan - 2 Feb	Standard – no disputes
Two	3 February	3 Feb - 15 Feb	Non-designated dispute accepted
Three	16 February	16 Feb - 1 Mar	Two designated disputes raised
Four	2 March	2 Mar - 15 Mar	Designated disputes – one raised, two in progress
Five	16 March	16 Mar - 30 Mar	Designated disputes – one accepted, one denied, one in progress

As indicated in the above table, a scenario will cover the period of time between the issue of the current invoice and the issue of next invoice.

Note

- **Dates, document numbers (i.e. invoice numbers etc) and monetary amounts are for illustrative purposes only.**
- **Volumes and types of consumption data are simplified to aid comprehension and are not intended to be representative of a typical Supplier.**
- **Template designs are subject to change.**
- **The example scenarios are for illustrative purposes only and do not preclude ESB Networks from following up for payments of overdue items outside of this regular process.**

6.2 Scenario One

The sequence of events in Scenario One is as follows:

Role	Description	Exhibit ID	MPD Step
N	DUoS invoice is created to include MPRNs billed during the current period (example, 1 st to 15 th January).		1
N	All relevant invoicing documentation is issued to Supplier via SFTS / EE on 19 th January.	D1.1 to D1.6	2
S	Supplier receives documentation and validates amount due to ESB Networks.		3
S	Supplier identifies no invoice items in dispute.		4,11
S	Supplier sends a 507C control message to ESB Networks indicating that the gross amount and number of designated disputes are nil.	D1.7	12
S	Supplier updates the remittance advice by inserting the 507C message amount (in this case €0.00) and returns the advice to ESB Networks.	D1.8	14
S	Supplier makes full payment for amount due via EFT on due date, which in the example has been calculated as 2 nd February.		22
N	ESB Networks receives and ensures that the 507C message, remittance advice and EFT amounts reconcile.		13, 21, 23, 24, 25
N	Finally, ESB Networks processes the payment against the Supplier account.		26

N = ESB Networks ; S = Supplier

Key points or features are noted below each exhibit. Scenario one includes new columns for ToU as a result of MCR1223.

6.3 Scenario Two

The sequence of events in Scenario Two is as follows:

Role	Description	Exhibit ID	MPD Step
N	DUoS invoice is created to include MPRNs billed during the current period (example , 16 th to 31 st January).		1
N	All relevant invoicing documentation is issued to Supplier via SFTS / EE on 3 rd February.	D2.1 to D2.6	2
S	Supplier receives documentation and validates amount due to ESB Networks.		3
S	Supplier notifies ESB Networks offline that there is one invoice item in dispute and that the dispute type is <i>non-designated</i> .	Highlighted in D2.3	4,5,15,
S	As there are no further disputes, the Supplier sends a 507C control message to ESB Networks indicating that the gross amount and number of <i>designated</i> disputes are nil.	D2.7	12
S	Supplier updates the remittance advice by inserting the 507C message amount (in this case €0.00) and returns the advice to ESB Networks.	D2.8	14
S	Supplier makes full payment for amount due via EFT on 15 th February (in advance of the due date, which in the example was calculated as 17 th February).		22
N	ESB Networks receives and ensures that the 507C message, remittance advice and EFT amounts reconcile.		13, 21, 23, 24, 25
N	ESB Networks processes the payment against the Supplier account.		26
N	ESB Networks investigates the non-designated dispute and resolves it in favour of the Supplier i.e. dispute is accepted.		17
N/S	ESB Networks confirms resolution of the dispute with the Supplier.		29, 30
N	ESB Networks performs necessary invoicing adjustments to reflect resolution of the dispute i.e. the original amount is reversed and the correct amount is re-invoiced. These adjustments will be reflected in the scenario three documentation.		31

N = ESB Networks ; S = Supplier

Key points or features are noted below each exhibit.

6.4 Scenario Three

The sequence of events in Scenario Three is as follows:

Role	Description	Exhibit ID	MPD Step
N	DUoS invoice is created to include MPRNs billed during the current period (example, 1 st to 14 th February) and the re-invoiced amount of the accepted non-designated dispute. A credit note is created for the reversal of the original amount of the dispute.		1
N	All relevant invoicing documentation is issued to Supplier via SFTS / EE on 16 th February.	D3.1 to D3.8	2
S	Supplier receives documentation and validates amount due to ESB Networks.		3
S	Supplier identifies two designated disputes on the current invoice. The registration of the MPRN is being challenged in both cases.	Highlighted in D3.4	4,5
S	The Supplier sends a 507 message for each designated dispute.	D3.9,D3.10	6
S	As there are no further disputes, the Supplier sends a 507C control message to ESB Networks indicating that the gross amount of designated disputes is €499.55 and the number is two.	D3.11	12
S	Supplier updates the remittance advice by inserting the 507C message amount of €499.55 and returns the advice to ESB Networks.	D3.12	14
S	Supplier pays the amount due via EFT on due date, which in the example has been calculated as 2 nd March.		22
N	ESB Networks receives and ensures that the 507C message, remittance advice and EFT amounts reconcile.		13, 21, 23, 24, 25
N	ESB Networks processes the payment against the Supplier account.		26
N	ESB Networks investigates the two designated disputes. In the example, it is assumed that the disputes are not resolved before commencement of scenario four.		17

N = ESB Networks ; S = Supplier

Key points or features are noted below each exhibit.

6.5 Scenario Four

The sequence of events in Scenario Four is as follows:

Role	Description	Exhibit ID	MPD Step
N	DUoS invoice is created to include MPRNs billed during the current period (example, 15 th to 28 th February).		1
N	All relevant invoicing documentation is issued to Supplier via SFTS / EE on 2 nd March.	D4.1 to D4.7	2
S	Supplier receives documentation and validates amount due to ESB Networks.		3
S	Supplier identifies one designated dispute on the current invoice. The registration of MPRN is being challenged.	Highlighted in D4.3.	4,5
S	The Supplier sends a 507 message for the designated dispute.	D4.8	6
S	As there are no further disputes, the Supplier sends a 507C control message to ESB Networks indicating that the gross amount of designated disputes is €290.74 and the number is one.	D4.9	12
S	Supplier updates the remittance advice by inserting the 507C message amount of €290.74 and returns the advice to ESB Networks.	D4.10	14
S	Supplier pays the amount due via EFT on due date, which in the example has been calculated as 16 th March.		22
N	ESB Networks receives and ensures that the 507C message, remittance advice and EFT amounts reconcile.		13,, 21, 23, 24, 25
N	ESB Networks processes the payment against the Supplier account.		26
N	ESB Networks investigates the current designated dispute. In the example, it is assumed that the dispute is not resolved before the commencement of scenario five.		17
N/S	ESB Networks reaches a resolution on the two designated disputes raised in Scenario three, on invoice number 900000000003. One dispute is accepted, the other denied. ESB Networks confirms this with the Supplier		29, 30
N	ESB Networks performs necessary invoicing adjustments to reflect resolution of the accepted dispute i.e. the original amount is reversed and the correct amount is re-invoiced. These adjustments will be reflected in the scenario five documentation.		31

N = ESB Networks ; S = Supplier

Key points or features are noted below each exhibit.

6.6 Scenario Five

The sequence of events in Scenario Five is as follows:

Role	Description	Exhibit ID	MPD Step
N	DUoS invoice is created to include MPRNs billed during the current period (example, 1 st to 14 th March) and for the re-invoiced amount of the accepted designated dispute. A credit note is created for the reversed original amount of the dispute.		1
N	All relevant invoicing documentation is issued to Supplier via SFTS / EE on 16 th March.	D5.1 to D5.8	2
S	Supplier receives documentation and validates amount due to ESB Networks.		3
S	Supplier decides no invoice items in dispute.		4,11
S	Supplier sends a 507C control message to ESB Networks indicating that the gross amount and number of designated disputes are nil.	D5.9	12
S	Supplier updates the remittance advice by inserting the 507C message amount (in this case €0.00) and returns the advice to ESB Networks.	D5.10	14
S	Supplier pays the amount due via EFT on due date, which in the example has been calculated as 30 th March.		22
N	ESB Networks receives and ensures that the 507C message, remittance advice and EFT amounts reconcile.		13,, 21, 23, 24, 25
N	ESB Networks processes the payment against the Supplier account.		26
N	ESB Networks is continuing to investigate the dispute raised in scenario four, on invoice number 90000000004. In the example, it is assumed that the dispute is not resolved before the commencement of the next scenario.		17

N = ESB Networks ; S = Supplier

Key points or features are noted below each exhibit.

6.8 DUoS Exhibits

Exhibit ID	Exhibit Name	Page
Scenario One		
D1.1	Invoice	25
D1.2	DUoS Group Summary	26
D1.3	MPRN Level Invoice Items Detail	27
D1.4	Account Statement	28
D1.5	Dispute Summary	29
D1.6	Remittance Advice sent to Supplier	30
D1.7	507C Control Market Message	31
D1.8	Remittance Advice returned by Supplier	32
Scenario Two		
D2.1	Invoice	33
D2.2	DUoS Group Summary	34
D2.3	MPRN Level Invoice Items Detail	35
D2.4	Account Statement	36
D2.5	Dispute Summary	37
D2.6	Remittance Advice sent to Supplier	38
D2.7	507C Control Market Message	39
D2.8	Remittance Advice returned by Supplier	40
Scenario Three		
D3.1	Invoice	41
D3.2	Credit Note	42
D3.3	DUoS Group Summary	43
D3.4	MPRN Level Invoice Items Detail	44
D3.5	Account Statement	45
D3.6	Dispute Summary	46
D3.7	Dispute Detail	47
D3.8	Remittance Advice sent to Supplier	48
D3.9	507 Market Message	49
D3.10	507 Market Message	49
D3.11	507C Control Market Message	50
D3.12	Remittance Advice returned by Supplier	51
Scenario Four		
D4.1	Invoice	52
D4.2	DUoS Group Summary	53
D4.3	MPRN Level Invoice Items Detail	54
D4.4	Account Statement	55
D4.5	Dispute Summary	56
D4.6	Dispute Detail	57
D4.7	Remittance Advice sent to Supplier	58
D4.8	507 Market Message	59
D4.9	507C Control Market Message	60
D4.10	Remittance Advice returned by Supplier	61
Scenario Five		
D5.1	Invoice	62
D5.2	Credit Note	63
D5.3	DUoS Group Summary	64
D5.4	MPRN Level Invoice Items Detail	65
D5.5	Account Statement	66
D5.6	Dispute Summary	67
D5.7	Dispute Detail	68
D5.8	Remittance Advice sent to Supplier	69
D5.9	507C Control Market Message	70
D5.10	Remittance Advice returned by Supplier	71

Exhibit ID: D1.1

Please quote this number when contacting ESB Networks DAC

ESB Networks DAC

Supplier Number

SX



Invoice Number

70100000000

Vat No. IE 9660798 N

Date: 06.08.2023

Payments / Enquiries to:

Power Supply
1 Any Street
Any Town

Billing & Income Office,
ESB Networks,
Sarsfield Road,
Wilton,
Cork.

DUoS Invoice	DOCUMENT	Value
<small>All payments must be made by electronic funds transfer, quoting the above invoice number, to AIB a/c 61907173, sorting code 932086. Payments of up</small>		
DUoS Charges for Current Billing		19,868.47
VAT@ 13.5%		2,682.24
Payment Terms:	10 Business Days	
Due Date:	20 th August 2019	
<small>ESB Networks DAC has an approved Complaints Handling Procedure that can be found on our website</small>		EURO TOTAL € 22,550.71

E.&O.E.

Please retain this counterfoil for your records

ESB Code: 9806667.1

Contract Account No

110200000000

Invoice No

70100000000

€ 22,550.71

Invoice for Demonstration Purposes Only



DUoS Group Summary Report

Invoice No: 900000000001

Date: 18/01/2023

Supplier No: SXX

Time: 01.30.15

DUoS Group	Total Records	Day - TOU		Night - TOU		24hr - TOU		Reactive kVArh	Other Charges		Surcharges		Day Off Peak		Night Off Peak		Peak		QH Day Off Peak		QH Night Off Peak		QH Peak		Total Net		Adjustments	
		kWh	Charges	kWh	Charges	kWh	Charges		Standing	Capacity	MIC	LPF	kWh	Charges	kWh	Charges	kWh	Charges	kWh	Charges	kWh	Charges	kWh	Charges	kWh	Charges	New Charges	Credits
DG1	8					851	33.34		85.8					3373	162.2	3009	18.38	247.4	11.9	0	0.00	0	0.00	0	0.00	311.62		
DG2	1								8.9					166	7.98	54	0.33	11.07	0.53	0	0.00	0	0.00	0	0.00	17.74		
DG3																												
DG4																												
DG5	2	4089	165.75	2465	12.23	2044	70.82	0	26.61	0.00	0.00	0.00	2641	136.84	2769.00	16.91	247.40	11.91	0	0.00	0	0.00	0	0.00	441.07			
DG6	5	50008	1031.16	19360	46.47	0	0	11874	555.95	1077.22	0.00	0.00	0.00	0.00	0.00	0.00	0.00	0.00	0	0.00	0	0.00	0	0.00	2710.80			
DG7	3	1101598	7138.40	410450	394.04	0	0	305411	566.67	7006.64	687.5	221.78	0.00	0.00	0.00	0.00	0.00	0.00	3853	199.64	7595	46.39	2622	126.18	16387.24			
DG8																												
DG9																												
DG10																												
Grand Total	19	1155695	8335.309	432275	452.74	2895	104.1647	317285	1243.93	8083.86	687.5	221.78	6180	307.02	5832	35.62	505.87	24.34	3853	199.64	7595	46.39	2622	126.18	19868.47	0.00	0.00	

*Points to Note: Grand total of 19,868.47 agrees to net invoice amount (D1.1).
The above format is for illustration purposes.*

MPRN Invoice Item Detail

Invoice No. 90000000001
 Sender ID DSO
 Recipient ID SXX
 Time/ Date 18/01/2023

Invoice No.	Invoice Item No.	MPRN	Adj. Ref.	Invoice Type	DUS Group	Billing Date From	Billing Date To	Day KWh Consumption	Day Energy Charge	Night KWh Consumption	Night Energy Charge	24 Hr KWh Consumption	24 Hr Energy Charge	Standing Charge	Capacity Charge	MFC	Max kVA	MFC Surcharge	Reactive Energy kvarh	Power Factor Surcharge	Day Off Peak KWh Consumption	Day Off Peak Energy Charge	Night Off Peak KWh Consumption	Night Off Peak Energy Charge	Peak KWh Consumption	Peak Energy Charge	QH Day Off Peak KWh Consumption	QH Day Off Peak Energy Charge	QH Night Off Peak KWh Consumption	QH Night Off Peak Energy Charge	QH Peak KWh Consumption	QH Peak Energy Charge	Net Amount	Gross Amount	
900000000001	100000000011100101	10099983660		DG1		01-Nov	02-Jan	0	0.00	0	0.00	0	0.00	11.31	0.00		0	0.00	0	0.00	412	19.81	1251	7.54	50	2.40	0	0.00	0	0.00	0	0.00	41.16	46.72	
900000000001	10000000000100101	10099983661	15	DG1		02-Nov	03-Jan	0	0.00	0	0.00	0	0.00	11.13	0.00		0	0.00	0	0.00	1945	93.54	1255	7.67	130	6.24	0	0.00	0	0.00	0	0.00	118.58	134.59	
900000000001	10000000000200101	10099983662	15	DG1		03-Nov	04-Jan	0	0.00	0	0.00	0	0.00	10.23	0.00		0	0.00	0	0.00	183	8.80	65	0.40	12	0.59	0	0.00	0	0.00	0	0.00	20.02	22.72	
900000000001	10000000000400101	10099983663	15	DG2		04-Nov	12-Dec	0	0.00	0	0.00	0	0.00	8.90	0.00		0	0.00	0	0.00	166	7.98	54	0.33	11.07	0.53	0	0.00	0	0.00	0	0.00	17.74	20.13	
900000000001	10000000000500101	10099983664	15	DG1		05-Nov	06-Jan	0	0.00	0	0.00	0	0.00	11.31	0.00		0	0.00	0	0.00	783	37.65	269	1.54	52	2.51	0	0.00	0	0.00	0	0.00	53.11	60.28	
900000000001	10000000000600101	10099983665	15	DG1		06-Nov	07-Jan	0	0.00	0	0.00	0	0.00	10.59	0.00		0	0.00	0	0.00	50	2.4	169	1.03	3	0.16	0	0.00	0	0.00	0	0.00	14.18	16.09	
900000000001	10000000000700101	10099983666	15	DG1		01-Dec	31-Dec	0	0.00	0	0.00	255	9.99	10.41	0.00		0	0.00	0	0.00	0	0.00	0	0.00	0	0.00	0	0.00	0	0.00	0	0.00	20.40	23.15	
900000000001	10000000000800101	10099983667	15	DG1		01-Dec	31-Dec	0	0.00	0	0.00	337	13.20	10.41	0.00		0	0.00	0	0.00	0	0.00	0	0.00	0	0.00	0	0.00	0	0.00	0	0.00	23.61	26.80	
900000000001	10000000000900101	10099983668	15	DG1		01-Dec	31-Dec	0	0.00	0	0.00	259	10.15	10.41	0.00		0	0.00	0	0.00	0	0.00	0	0.00	0	0.00	0	0.00	0	0.00	0	0.00	20.56	23.34	
900000000001	10000000001000101	10099983673	15	DG5		01-Nov	02-Jan	4089	165.75	2465	12.23	0	14.05	0.00	30		0	0.00	0	0.00	0	0.00	0	0.00	0	0.00	0	0.00	0	0.00	0	0.00	192.03	217.95	
900000000001	10000000002000101	10099983674	15	DG5		02-Nov	03-Jan	0	0	0	0	2044	70.82	12.56	0.00	30		0	0.00	0	0.00	2641	136.84	2769	16.91	247.40	11.91	0	0.00	0	0.00	0	0.00	249.04	282.66
900000000001	10000000003000101	10099983675	15	DG6		03-Nov	04-Jan	23356	481.6	9261	22.23	0	120.36	361.22	80		0	0.00	4523	0.00	0	0.00	0	0.00	0	0.00	0	0.00	0	0.00	0	0.00	985.41	1118.44	
900000000001	10000000004000101	10099983676	15	DG6		04-Nov	12-Dec	4523	93.26	1890	4.54	0	74.51	83.86	30		0	0.00	1283	0.00	0	0.00	0	0.00	0	0.00	0	0.00	0	0.00	0	0.00	256.17	290.75	
900000000001	10000000005000101	10099983677	15	DG6		05-Nov	06-Jan	11711	241.48	4643	11.14	0	120.36	270.92	60		0	0.00	3271	0.00	0	0.00	0	0.00	0	0.00	0	0.00	0	0.00	0	0.00	643.90	730.83	
900000000001	10000000006000101	10099983678	15	DG6		06-Nov	07-Jan	3243	66.87	721	1.73	0	120.36	225.76	50		0	0.00	793	0.00	0	0.00	0	0.00	0	0.00	0	0.00	0	0.00	0	0.00	414.72	470.71	
900000000001	10000000007000101	10099983679	15	DG6		07-Nov	08-Jan	7175	147.95	2845	6.83	0	120.36	135.46	30		0	0.00	2004	0.00	0	0.00	0	0.00	0	0.00	0	0.00	0	0.00	0	0.00	410.60	466.03	
900000000001	10000000008000101	10099983680	15	DG7		01-Dec	31-Dec	351573	2,278.19	106111	101.87	0	188.89	1,808.84	1305		980	0.00	12123	0.00	0	0.00	0	0.00	0	0.00	793	41.09	1543	9.42	522	25.12	4453.43	5054.64	
900000000001	10000000009000101	10099983681	15	DG7		01-Dec	31-Dec	436412	2,827.95	164069	157.51	0	188.89	3,118.68	2250		2423	687.5	278963	221.78	0	0.00	0	0.00	0	0.00	1956	101.35	3157	19.28	1150	55.34	7378.28	8374.35	
900000000001	10000000010000101	10099983682	15	DG7		01-Dec	31-Dec	313613	2,032.21	140270	134.66	0	188.89	2,079.12	1500		997	0	14325	0	0	0.00	0	0.00	0	0.00	1104	57.20	2895	17.68	950	45.72	4555.48	5170.47	
Total Records		Control Total																																	
	19	19868.47																																	

- Points to Note: (1) Control Total of €19,868.47 agrees to net invoice amount (D1.1).
 (2) The above format is for illustration purposes. The flat file as issued by ESB Networks will not contain row headings etc. Detailed guidelines for using the file are included in Section 9 of this document.
 (3) Recipient ID is the same as the Supplier number, in the example SXX.
 The above format is for illustration purposes.



DUoS Statement of Account
Date: 01/01/23 to 19/01/23

Supplier No: SXX
 Contract Account No: 116000000001
 Address: 1 Any Street, Any Town

Date	Ref No.	Description	Amount	Balance
			€	€
01/01/23		Opening balance		0.00
19/01/23	900000000001	DUoS Charges for Current Billing Period	22,550.71	22,550.71
19/01/23		Closing balance		22,550.71
		Designated Disputes in Progress		0.00
		Amount Due		22,550.71

*Points to Note: Assume nil opening balance. Only movement on Supplier account is invoice issued on 19th January.
 Contract account number indicates the account type, in the example, the Supplier DUoS Account.
 The above format is for illustration purposes.*



DUoS Charges - Dispute Summary

Date: 01/01/05 to 19/01/05

Supplier No: SXX116000000001
 Contract Account No: 1 Any Street, Any Town
 Address:

Designated Disputes

Invoice Date	Invoice No.	Disputes In Progress	Disputes Accepted	Disputes Denied
		€	€	€
Total		0.00	0.00	0.00

Resolved Amounts Now Due	0.00	0.00
---------------------------------	-------------	-------------

Non Designated Disputes

Invoice Date	Invoice No.	Disputes In Progress	Disputes Accepted	Disputes Denied
		€	€	€
Total		0.00	0.00	0.00

Points to Note: No details reported for scenario one as no disputes in progress or resolved during the period covered by the Summary.

Exhibit ID: D1.6

Remittance Advice

<u>Current Inv (C)/Resolved</u>	<u>Invoice No.</u>	<u>MPRN</u>	<u>Invoice Item No.</u>	<u>Invoice Amount</u>	<u>Control Message Amount</u>	<u>Payment Amount</u>
<u>Desig. Dispute (R)</u> C	701000000001	See MPRN Level	Invoice Item Detail	22,550.71		22,550.71

Key:

EFT Amount

22,550.71

Input by Supplier - All Other cells are locked

Points to Note: This is the remittance advice as sent to the Supplier. Amount due for payment is as per invoice issued on 19th January. Gross invoice amount defaults into Payment Amount and EFT Amount.

The remittance advice as completed by the Supplier and returned to ESB Networks is shown on D1.8.

Exhibit ID: D1.7

Header Level	Message Header	
Information – Level 1	Message Type	507C
	Version number	01.00.00
	Time Stamp	2023-01-31-09-15-15
	Senders ID	SXX
	Recipient ID	DSO
	Transaction Reference number	A1110001
MPRN Level Information – Level 2	Meter Point Reference Number	
	Market Participant Business Reference	
	Invoice No	900000000001
	Invoice Item No	
	Dispute Reason	
	Amount Disputed Total	0
	Number of dispute records	0

Points to Note:

(1) 507C message - no designated disputes raised on the current invoice in this scenario i.e. no 507 messages raised by Supplier.

(2) Guidelines for sending 507C messages are included in the Market Message Implementation Guide – Common Data Segments and the Market Message Implementation Guide – DUoS and Transaction Payments.

Exhibit ID: D1.8

Remittance Advice

<u>Current Inv (C)/Resolved Desig. Dispute (R)</u>	<u>Invoice No.</u>	<u>MPRN</u>	<u>Invoice Item No.</u>	<u>Invoice Amount</u>	<u>Control Message Amount</u>	<u>Payment Amount</u>
C	900000000001	See MPRN Level	Invoice Item Detail	22,550.71	0.00	22,550.71

Key:

EFT Amount

22,550.71

Input by Supplier - All Other cells are locked

Points to Note: This is the remittance advice as completed by the Supplier. The Supplier inserts 507C message amount into the Control Message Amount cell, which automatically calculates Payment and EFT Amounts.



DUoS Supplier Invoice

Supplier No: SXX Invoice No: 90000000000
2
Date: 03/02/2023

Power Supply
1 Any Street
Any Town

Payment Enquiries to:
Billing & Income
Office
ESB Networks Sarsfield Rd Wilton
Cork T12 E367

Description	Amount
DUoS Charges for Current Billing Period	3,096.43
VAT @ 13.5%	418.02
Total EUR	3,514.45

Payment terms: 10 Business
Days

Due Date: 17/02/2023

All payments must be made by electronic transfer quoting the above invoice number to AIB A/c No. xxxxx xxxxx sort code xx-xx-xx. Payments of up to €1,270 can be made by cheque made payable to ESB Networks at the above address quoting the above invoice number.

Exhibit ID: D2.2



DUoS Group Summary Report

Invoice No: 900000000002

Date: 02/02/2023

Supplier No: SXX

Time: 01.30.15

DUoS Group	Total Records	Day - TOU		Night - TOU		24hr - TOU		Reactive kVAh	Other Charges		Surcharge		Day Off Peak		Night Off Peak		Peak		QH Day Off Peak		QH Night Off Peak		QH Peak		Total Net		Adjustments		
		kWh	Charge	kWh	Charge	kWh	Charges		Standing	Capacity	MIC	LPF	kWh	Charges	kWh	Charges	kWh	Charges	kWh	Charges	kWh	Charges	kWh	Charges	kWh	Charges	New Charges	Credits	Debits
DG1																													
DG2																													
DG3																													
DG4																													
DG5	5	63766	1,314.86	21229	50.95	0	0.00	12999	601.80	1,128.82	0.00	0.00	0.00	0.00	0.00	0.00	0.00	0.00	0.00	0.00	0.00	0.00	0.00	0.00	0.00	0.00	3096.43		
DG6																													
DG7																													
DG8																													
DG9																													
DG10																													
Grand Total	5	0	0	0	0.00	0	0	0	0	0	0	0	0	0.00	0	0.00	0	0.00	0	0.00	0	0.00	0	0.00	0	0.00	3096.43	0.00	0.00
																											Grand Total		3096.43

*Points to Note: Grand total of €3,096.43 agrees to net invoice amount (D2.1).
The above format is for illustration purposes.*

Exhibit ID: D2.3

MPRN Invoice Item Detail

Invoice No. 900000000002
 Sender ID DSD
 Recipient ID SKX
 Time/ Date 02/02/2023

Invoice No.	Invoice Item No.	MPRN	Adj. Ref.	Invoice Type	DUSG Group	Billing Date From	Billing Date To	Day kWh Consumption	Day Energy Charge	Night kWh Consumption	Night Energy Charge	24 Hr kWh Consumption	24 Hr Energy Charge	Standing Charge	Capacity Charge	MIC	Max kVA	MIC Surcharge	Reactive Energy kWh	Power Factor Surcharge	Day Off Peak kWh Consumption	Day Off Peak Energy Charge	Night Off Peak kWh Consumption	Night Off Peak Energy Charge	Peak kWh Consumption	Peak Energy Charge	QH Day Off Peak kWh Consumption	QH Day Off Peak Energy Charge	QH Night Off Peak kWh Consumption	QH Night Off Peak Energy Charge	QH Peak kWh Consumption	QH Peak Energy Charge	Net Amount	Gross Amount	
900000000002	100000000013000101	10099983683	15	DG6		20-Nov	21-Jan	33356	687.80	9261	22.23	0	0.00	120.36	361.22	80	0	0.00	4523	0.00	0	0.00	0	0.00	0	0.00	0	0.00	0	0.00	0	0.00	1191.61	1352.48	
900000000002	100000000014000101	10099983684	15	DG6		21-Nov	22-Jan	8481	174.88	3759	9.02	0	0.00	120.36	135.46	30	0	0.00	2448	0.00	0	0.00	0	0.00	0	0.00	0	0.00	0	0.00	0	0.00	439.72	499.08	
900000000002	100000000015000101	10099983685	15	DG6		22-Nov	23-Jan	10711	220.86	4643	11.14	0	0.00	120.36	270.92	60	0	0.00	3071	0.00	0	0.00	0	0.00	0	0.00	0	0.00	0	0.00	0	0.00	623.28	707.42	
900000000002	100000000016000101	10099983686	15	DG6		23-Nov	24-Jan	3543	73.06	721	1.73	0	0.00	120.36	225.76	50	0	0.00	853	0.00	0	0.00	0	0.00	0	0.00	0	0.00	0	0.00	0	0.00	420.91	477.73	
900000000002	100000000017000101	10099983687	15	DG6		24-Nov	25-Jan	7675	158.26	2845	6.83	0	0.00	120.36	135.46	30	0	0.00	2104	0.00	0	0.00	0	0.00	0	0.00	0	0.00	0	0.00	0	0.00	420.91	477.73	
Total Records		Control Total																																	
		5						3096.43																											

Points to Note: Control total of €3,096.43 agrees to net invoice amount (D2.1).
 Item highlighted in green will be identified by the Supplier as a non-designated dispute.
 The above format is for illustration purposes.



DUoS Statement of Account

Date: 20/01/23 to 03/02/23

Supplier No: SXX
 Contract Account No: 116000000001
 Address: 1 Any Street, Any Town

Date	Ref No.	Description	Amount	Balance
			€	€
20/01/23		Opening balance		22,550.71
02/02/23		Payment	-22,550.71	0.00
03/02/23	900000000002	DUoS Charges for Current Billing Period	3,514.45	3,514.45
03/02/23		Closing balance		3,514.45
		Designated Disputes in Progress		0.00
		Amount Due		3,514.45

Points to Note: Opening balance is brought forward from previous statement. Movements on Supplier account were payment made by Supplier on 2nd February and invoice issued on 3rd February by ESB Networks.



DUoS Charges - Dispute Summary

Date: 20/01/23 to 03/02/23

Supplier No: SXX
 Contract Account No: 116000000001
 Address: 1 Any Street, Any Town

Designated Disputes

Invoice Date	Invoice No.	Disputes In Progress	Disputes Accepted	Disputes Denied
		€	€	€
Total		0.00	0.00	0.00

Resolved Amounts Now Due	0.00	0.00
---------------------------------	-------------	-------------

Non Designated Disputes

Invoice Date	Invoice No.	Disputes In Progress	Disputes Accepted	Disputes Denied
		€	€	€
Total		0.00	0.00	0.00

Points to Note: No details reported for scenario two as no disputes in progress or resolved during the period covered by the Summary.

Exhibit ID: D2.6

Remittance Advice

<u>Current Inv (C)/Resolved Desig. Dispute (R)</u>	<u>Invoice No.</u>	<u>MPRN</u>	<u>Invoice Item No.</u>	<u>Invoice Amount</u>	<u>Control Message Amount</u>	<u>Payment Amount</u>
C	900000000002	See MPRN Level	Invoice Item Detail	3,514.45		3,514.45

Key:

EFT Amount

3,514.45

Input by Supplier - All Other cells are locked

Points to Note: This is the remittance advice as sent to the Supplier. The amount due for payment is as per invoice issued on 3rd February. Gross invoice amount defaults into Payment Amount and EFT Amount.

The remittance advice as completed by the Supplier and returned to ESB Networks is shown on D2.8.

Exhibit ID: D2.7

Header Level	Message Header	
Information – Level 1	Message Type	507C
	Version number	01.00.00
	Time Stamp	2023-02-16-10-20-05
	Senders ID	SXX
	Recipient ID	DSO
	Transaction Reference number	A1120001
MPRN Level Information – Level 2	Meter Point Reference Number	
	Market Participant Business Reference	
	Invoice No	900000000002
	Invoice Item No	
	Dispute Reason	
	Amount Disputed Total	0
	Number of dispute records	0

Points to Note: 507C message - no designated disputes raised on invoice in this scenario i.e. no 507 messages raised by Supplier.

Exhibit ID: D2.8

Remittance Advice

<u>Current Inv. /Resolved Desig. Dispute</u>	<u>Invoice No.</u>	<u>MPRN</u>	<u>Invoice Item No.</u>	<u>Invoice Amount</u>	<u>Control Message Amount</u>	<u>Payment Amount</u>
C	900000000002	See MPRN Level	Invoice Item Detail	3,514.45	0.00	3,514.45

Key:

EFT Amount

3,514.45

Input by Supplier - All Other cells are locked

Points to Note: This is the remittance advice as completed by the Supplier. The Supplier inserts 507C message amount into the Control Message Amount, which automatically calculates the Payment and EFT Amounts.



DUoS Supplier Invoice

Supplier No: SXX Invoice No: 90000000000
 Date: 16/02/2023

Power Supply
 1 Any Street
 Any Town

Payment Enquiries to:
 Billing & Income
 Office
 ESB Networks Sarsfield Rd Wilton
 Cork T12 E367

Description	Amount
DUoS Charges for Current Billing Period	20,251.05
VAT @ 13.5%	2,733.89
Adjustment Debit Charges	1,014.10
VAT @ 13.5%	136.90
Total EUR	24,135.94

Payment terms: 10 Business Days

Due Date: 02/03/2023

All payments must be made by electronic transfer quoting the above invoice number to AIB A/c No. xxxxx xxxxx sort code xx-xx-xx. Payments of up to €1,270 can be made by cheque made payable to ESB Networks at the above address quoting the above invoice number.

Points to Note: Two net amounts on invoice, one for current charges and a second line relating to the re-invoiced amount for the accepted non-designated dispute. This dispute was raised by the Supplier in scenario two on invoice item number 100000000013000101. The original amount invoiced in scenario two has been reversed. Refer to credit note on D3.2.



DUoS Supplier Credit Note

Supplier No: SXX **Invoice No:** 900000000003
Date: 16/02/2005

Power Supply
1 Any Street
Any Town

Payment Enquiries to:
Billing & Income Office
ESB Networks Sarsfield Rd Wilton
Cork T12 E367

Description	Amount	
Adjustment Credit Charges	1,191.61	C R
VAT @ 13.5%	160.87	C R
Total EUR	1,352.48	C R

All payments must be made by electronic transfer quoting the above invoice number to AIB A/c No. xxxxx xxxxx sort code xx-xx-xx. Payments of up to €1,270 can be made by cheque made payable to ESB Networks at the above address quoting the above invoice number.

Points to Note: Adjustment credit relates to reversal of amount of accepted non-designated dispute raised by Supplier in scenario two.

Exhibit ID: D3.3



DUoS Group Summary Report

Invoice No: 900000000003

Date: 15/02/2023

Supplier No: SXX

Time: 01.30.15

DUoS Group	Total Records	Day - TOU		Night - TOU		24hr - TOU		Reactive	Other Charges		Surcharges		Day Off Peak		Night Off Peak		Peak		QH Day Off Peak		QH Night Off Peak		QH Peak		Total Net New Charges	Adjustments			
		kWh	Charges	kWh	Charges	kWh	Charges		kVArh	Standing	Capacity	MIC	LPF	kWh	Charges	kWh	Charges	kWh	Charges	kWh	Charges	kWh	Charges	kWh		Charges	Credits	Debits	
DG1																													
DG2																													
DG3																													
DG4																													
DG5	2	9585	388.39	4677	23.20	0	0.00	0	28.54	0	0	0.00	0	0.00	0	0.00	0	0.00	0	0.00	0	0.00	0	0.00	0	0.00	440.13		
DG6	7	55642	1147.34	18937	45.44	0	0.00	14916	613.26	1192.62	0.00	0.00	0	0.00	0	0.00	0	0.00	0	0.00	0	0.00	0	0.00	0	0.00	2998.66	-1191.61	1014.10
DG7	3	1123595	7280.94	484022	462.03	0	0.00	305411	566.67	7222.88	297.84	260.03	0	0.00	0	0.00	0	0.00	4853	251.45	7595	46.39	2622	126.18	16812.26				
DG8																													
DG9																													
DG10																													
Grand Total	12	1188822	8816.6722	507636	530.67	0	0	320327	1208.47	8415.5	297.84	260.03	0	0.00	0	0.00	0	0.00	4853	251.45	7595	46.39	2622	126.18	20251.05	-1191.61	1014.10		
																											Grand Total		20073.54

Points to Note:

- Total of New Charges agrees to net invoice amount for current charges (D3.1).
- Total of Adjustment Credits agrees to net credit note amount (D3.2).
- Total of Adjustment Debits agrees to net adjustment debit amount (D3.1).
- The above format is for illustration purposes.

Points to Note: Control total agrees to sum of net invoice and credit note amounts (D3.1 and D3.2).

MPRN Invoice Item Detail

Invoice No. 90000000003
 Sender ID DSO
 Recipient ID SXK
 Time/Date 15/02/2023

Invoice No.	Invoice Item No.	MPRN	Adj. Ref.	Invoice Type	DUoS Group	Billing Date From	Billing Date To	Day kWh Consumption	Day Energy Charge	Night kWh Consumption	Night Energy Charge	24 Hr kWh Consumption	24 Hr Energy Charge	Standing Charge	Capacity Charge	MFC	Max kVA	MFC Surcharge	Reactive Energy kWh	Power Factor Surcharge	Day Off Peak kWh Consumption	Day Off Peak Energy Charge	Night Off Peak kWh Consumption	Night Off Peak Energy Charge	Peak kWh Consumption	Peak Energy Charge	QH Day Off Peak kWh Consumption	QH Day Off Peak Energy Charge	QH Night Off Peak kWh Consumption	QH Night Off Peak Energy Charge	QH Peak kWh Consumption	QH Peak Energy Charge	Net Amount	Gross Amount
90000000003	10000000021000101	10099983683	10000000013000101	25	DG6	20-Nov	21-Jan	-33356	-687.80	-9261	-22.23	0	0.00	-120.36	-361.22	80	0	0.00	-4523	0.00	0	0.00	0	0.00	0	0.00	0	0.00	0	0.00	0	0.00	-1191.61	-1352.48
90000000003	10000000022000101	10099983683		35	DG6	10-Nov	11-Jan	25017	515.85	6946	16.67	0	0.00	120.36	361.22	80	0	0.00	3392	0.00	0	0.00	0	0.00	0	0.00	0	0.00	0	0.00	0	0.00	1014.10	1151.00
90000000003	10000000023000101	10099983690		15	DG5	01-Dec	02-Feb	4724	191.42	2534	12.57	0	0.00	14.27	0.00	30	0	0.00	0	0.00	0	0.00	0	0.00	0	0.00	0	0.00	0	0.00	0	0.00	218.26	247.73
90000000003	10000000024000101	10099983691		15	DG5	01-Dec	02-Feb	4861	196.97	2543	10.63	0	0.00	14.27	0.00	30	0	0.00	0	0.00	0	0.00	0	0.00	0	0.00	0	0.00	0	0.00	0	0.00	221.87	251.82
90000000003	10000000025000101	10099983692		15	DG6	01-Dec	02-Feb	25431	524.39	7634	18.32	0	0.00	122.27	321.09	70	0	0.00	6613	0.00	0	0.00	0	0.00	0	0.00	0	0.00	0	0.00	0	0.00	986.07	1119.19
90000000003	10000000026000101	10099983693		15	DG6	01-Dec	02-Feb	7481	154.25	2759	6.62	0	0.00	122.27	137.61	30	0	0.00	2048	0.00	0	0.00	0	0.00	0	0.00	0	0.00	0	0.00	0	0.00	420.76	477.56
90000000003	10000000027000101	10099983694		15	DG6	01-Dec	02-Feb	11711	241.48	4743	11.38	0	0.00	124.18	321.09	70	0	0.00	3291	0.00	0	0.00	0	0.00	0	0.00	0	0.00	0	0.00	0	0.00	698.13	792.38
90000000003	10000000028000101	10099983695		15	DG6	01-Dec	02-Feb	2674	55.14	834	2.00	0	0.00	122.27	275.22	60	0	0.00	702	0.00	0	0.00	0	0.00	0	0.00	0	0.00	0	0.00	0	0.00	454.63	516.01
90000000003	10000000029000101	10099983696		15	DG6	01-Dec	02-Feb	8345	172.07	2967	7.12	0	0.00	122.27	137.61	30	0	0.00	2262	0.00	0	0.00	0	0.00	0	0.00	0	0.00	0	0.00	0	0.00	439.07	498.34
90000000003	10000000030000101	10099983680		15	DG7	01-Jan	31-Jan	382346	2,477.60	106111	101.29	0	0.00	188.89	1947.45	1405	1324	281.36	12123	0.00	0	0.00	0	0.00	0	0.00	2358	122.18	3684	22.50	1256	60.44	5201.71	5903.94
90000000003	10000000031000101	10099983681		15	DG7	01-Jan	31-Jan	456682	2,959.30	212569	202.91	0	0.00	188.89	3257.29	2350	2423	178.69	278963	260.03	0	0.00	0	0.00	0	0.00	1569	81.30	2465	15.06	925	44.51	7187.98	8158.35
90000000003	10000000032000101	10099983682		15	DG7	01-Jan	31-Jan	284567	1,843.99	165342	157.83	0	0.00	188.89	2018.14	1456	1047	135.68	14325	0.00	0	0.00	0	0.00	0	0.00	926	47.98	1446	8.83	441	21.22	4422.57	5019.61
Total Records	Control Total																																	
	12	20073.54																																

Item highlighted in red is reversal of accepted non-designated dispute item.
 Item highlighted in blue in re-invoicing of accepted non-designated dispute item.
 Items highlighted in green will be identified by the Supplier as designated disputes (D3.9 and D3.10).
 The above format is for illustration purposes.



DUoS Statement of Account
Date: 04/02/23 to 16/02/23

Supplier No: SXX
 Contract Account No: 116000000001
 Address: 1 Any Street, Any Town

Date	Ref No.	Description	Amount	Balance
			€	€
04/02/23		Opening balance		3,514.45
15/02/23		Payment	-3,514.45	0.00
16/02/23	900000000003	Adjustment Credit Charges	-1,352.48	-1,352.48
16/02/23	900000000003	Adjustment Debit Charges	1,151.00	-201.48
16/02/23	900000000003	DUoS Charges for Current Billing Period	22,984.94	22,783.46
16/02/23		Closing balance		22,783.46
		Designated Disputes in Progress		0.00
		Amount Due		22,783.46

Points to Note: The two debit amounts as per the invoice and the credit amount as per the credit note are shown separately on the account statement.



DUoS Charges - Dispute Summary

Date: 04/02/23 to 16/02/23

Supplier No: SXX
 Contract Account No: 116000000001
 Address: 1 Any Street, Any Town

Designated Disputes

Invoice Date	Invoice No.	Disputes In Progress	Disputes Accepted	Disputes Denied
		€	€	€
Total		0.00	0.00	0.00

Resolved Amounts Now Due	0.00	0.00
---------------------------------	-------------	-------------

Non Designated Disputes

Invoice Date	Invoice No.	Disputes In Progress	Disputes Accepted	Disputes Denied
		€	€	€
03/02/2023	900000000002		1,352.48	
Total		0.00	1,352.48	0.00

Points to Note: The non-designated dispute section now shows that disputes totalling €1,352.48 relating to invoice number 900000000002 were accepted during the period covered by the summary.

Exhibit ID: D3.7

DUoS Charges - Dispute Detail

Date: 04/02/23 to 16/02/23

Supplier No: SXX
Address: 1 Any Street, Any Town

Invoice No.	Invoice Item No.	MPRN	Gross Amount	Dispute Type	Reason Code	Dispute Status	Raised On	Resolved On
900000000002	100000000013000101	10099983683	1,352.48	ND		Accepted	10/02/2023	12/02/2023
Total Records	1							
End								

Points to Note: In the example only one invoice item was disputed on invoice number 90000000002 (refer to D2.3 for details). The report shows the dates on which the dispute was raised and resolved, the dispute type as ND for non-designated and the status as Accepted.

Exhibit ID: D3.8

Remittance Advice						
<u>Current Inv. /Resolved</u>	<u>Invoice No.</u>	<u>MPRN</u>	<u>Invoice Item No.</u>	<u>Invoice Amount</u>	<u>Control Message Amount</u>	<u>Payment Amount</u>
<u>Desig. Dispute</u> C	900000000003	See MPRN	Invoice Item Detail	22,783.46	0.00	22,783.46
Key:					EFT Amount	22,783.46
Input by Supplier - All Other cells are locked						

Points to Note: This is the remittance advice as sent to the Supplier. The amount due for payment is the sum of the invoice and credit note issued on 16th February. Gross amount defaults into Payment Amount and EFT Amount.

The remittance advice as completed by the Supplier and returned to ESB Networks is shown in D3.12.

Exhibit ID: D3.9

Header Level	Message Header	
Information – Level 1	Message Type	507
	Version number	01.00.00
	Time Stamp	2023-02-20-11-25-05
	Senders ID	SXX
	Recipient ID	DSO
	Transaction Reference number	A1130001
	MPRN Level	
Information – Level 2	Meter Point Reference Number	10099983690
	Market Participant Business Reference	
	Invoice No	900000000003
	Invoice Item No	100000000023000101
	Dispute Reason	SNR
	Amount Disputed Total	
	Number of dispute records	

Exhibit ID: D3.10

Header Level	Message Header	
Information – Level 1	Message Type	507
	Version number	01.00.00
	Time Stamp	2023-02-21-12-30-20
	Senders ID	SXX
	Recipient ID	DSO
	Transaction Reference number	A1130002
	MPRN Level	
Information – Level 2	Meter Point Reference Number	10099983691
	Market Participant Business Reference	
	Invoice No	900000000003
	Invoice Item No	100000000024000101
	Dispute Reason	SNR
	Amount Disputed Total	
	Number of dispute records	

Points to Note: Using data in the MPRN Level Invoice Item Detail file (D3.4), the Supplier inserts MPRN, invoice number, invoice item number and dispute reason. In the example, a dispute reason of SNR is used as the Supplier is disputing registration of the MPRN's.

Refer to Market Message Implementation Guide – Common Data Segments and Message Implementation Guide – DUoS and Transaction Payments for guidelines to sending 507 messages.

Exhibit ID: D3.11

Header Level	Message Header	
Information – Level 1	Message Type	507C
	Version number	01.00.00
	Time Stamp	2023-03-01-09-05-15
	Senders ID	SXX
	Recipient ID	DSO
	Transaction Reference number	A1130003
MPRN Level Information – Level 2	Meter Point Reference Number	
	Market Participant Business Reference	
	Invoice No	900000000003
	Invoice Item No	
	Dispute Reason	
	Amount Disputed Total	499.55
	Number of dispute records	2

Points to Note: 507C message- the Supplier raised two designated disputes on the invoice in this scenario. i.e. two 507 messages were raised by Supplier.

Exhibit ID: D3.12

Remittance Advice						
<u>Current Inv. /Resolved Desig. Dispute</u>	<u>Invoice No.</u>	<u>MPRN</u>	<u>Invoice Item No.</u>	<u>Invoice Amount</u>	<u>Control Message Amount</u>	<u>Payment Amount</u>
C	900000000003	See MPRN Invoice Item Detail		22,783.46	499.55	22,283.91
Key:					EFT Value	22,283.91
Input by Supplier - All Other cells are locked						

Points to Note: This is the remittance advice as completed by the Supplier. The Supplier inserts 507C message amount of €499.55 into Control Message Amount cell. This automatically calculates the Payment Amount and EFT Amount. In the example, the Supplier is withholding payment of the gross amount of the two designated disputes raised on the current invoice.



DUoS Supplier Invoice

Supplier No: SXX **Invoice No:** 900000000004
Date: 02/03/2023

Power Supply
1 Any Street
Any Town

Payment Enquiries to:
Billing & Income Office
ESB Networks Sarsfield Road Wilton
Cork T12 E367

Description	Amount
DUoS Charges for Current Billing Period	2,845.63
VAT @ 13.5%	384.16
Total EUR	3,229.79

Payment terms: 10 Business Days

Due Date: 16/03/2023

All payments must be made by electronic transfer quoting the above invoice number to AIB A/c No. xxxxx xxxxx sort code xx-xx-xx. Payments of up to €1,270 can be made by cheque made payable to ESB Networks at the above address quoting the above invoice number.

Exhibit ID: D4.2



DUoS Group Summary Report

Invoice No: 900000000004

Date: 01/03/2023

Supplier No: SXX

Time: 01.30.15

DUoS Group	Total Records	Day - TOU		Night - TOU		24hr - TOU		Reactive	Other Charges		Surcharges		Day Off Peak		Night Off Peak		Peak		QH Day Off Peak		QH Night Off Peak		QH Peak		Total Net	Adjustments			
		kWh	Charge	kWh	Charge	kWh	Charges	kVArh	Standing	Capacity	MIC	LPF	kWh	Charges	kWh	Charges	kWh	Char	kWh	Charges	kWh	Charges	kWh	Charges	New Charges	Credits	Debits		
DG1																													
DG2																													
DG3																													
DG4																													
DG5	2	5674	229.91	2550	12.65	4976	172.42	0	25.76	0	0	0.00	0	0.00	0	0.00	0	0.00	0	0.00	0	0.00	0	0.00	0	0.00	440.74		
DG6	4	45450	937.18	16549	39.71	0	0.00	12400	466.16	961.84	0.00	0.00	0	0.00	0	0.00	0	0.00	0	0.00	0	0.00	0	0.00	0	0.00	2404.89	0.00	0.00
DG7																													
DG8																													
DG9																													
DG10																													
Grand Total	6	51124	1167.09	19099	52.36	4976	172.42	12400	491.92	961.84	0	0	0	0.00	0	0.00	0	0.00	0	0.00	0	0.00	0	0.00	0	0.00	2845.63	0.00	0.00
																												Grand Total	2845.63

Points to Note: Grand total of €2,845.63 agrees to net invoice amount (D4.1).
The above format is for illustration purposes.

Exhibit ID: D4.3

MPRN Invoice Item Detail

Invoice No. 900000000004
 Sender ID DSO
 Recipient ID SXK
 Time/Date 01/03/2023

Invoice No.	Invoice Item No.	MPRN	Adj. Ref.	Invoice Type	DUES Group	Billing Date From	Billing Date To	Day kWh Consumption	Day Energy Charge	Night kWh Consumption	Night Energy Charge	24 Hr kWh Consumption	24 Hr Energy Charge	Standing Charge	Capacity Charge	MTC	Max kVA	MTC Surcharge	Reactive Energy kWh	Power Factor Surcharge	Day Off Peak kWh Consumption	Day Off Peak Energy Charge	Night Off Peak kWh Consumption	Night Off Peak Energy Charge	Peak kWh Consumption	Peak Energy Charge	QH Day Off Peak kWh Consumption	QH Day Off Peak Energy Charge	QH Night Off Peak kWh Consumption	QH Night Off Peak Energy Charge	QH Peak kWh Consumption	QH Peak Energy Charge	Net Amount	Gross Amount	
900000000004	100000000031000101	10099983697	15	DG5		24-Dec	22-Feb	5674	229.91	2550	12.65	0	0.00	13.60	0.00	30	0	0.00	0	0.00	0	0.00	0	0.00	0	0.00	0	0.00	0	0.00	0	0.00	256.16	290.74	
900000000004	100000000032000101	10099983699	15	DG5		25-Dec	23-Feb	0	0.00	0	0.00	4976	172.42	12.16	0.00	30	0	0.00	0	0.00	0	0.00	0	0.00	0	0.00	0	0.00	0	0.00	0	0.00	184.58	209.50	
900000000004	100000000033000101	10099983701	15	DG6		26-Dec	24-Feb	24513	505.46	8879	21.31	0	0.00	116.54	349.76	80	0	0.00	6678	0.00	0	0.00	0	0.00	0	0.00	0	0.00	0	0.00	0	0.00	993.07	1127.13	
900000000004	100000000034000101	10099983703	15	DG6		28-Dec	26-Feb	10987	226.55	4456	10.69	0	0.00	116.54	262.32	60	0	0.00	3089	0.00	0	0.00	0	0.00	0	0.00	0	0.00	0	0.00	0	0.00	616.10	699.27	
900000000004	100000000035000101	10099983705	15	DG6		29-Dec	27-Feb	3016	62.19	668	1.60	0	0.00	116.54	218.60	50	0	0.00	737	0.00	0	0.00	0	0.00	0	0.00	0	0.00	0	0.00	0	0.00	398.93	452.79	
900000000004	100000000036000101	10099983707	15	DG6		30-Dec	28-Feb	6934	142.98	2546	6.11	0	0.00	116.54	131.16	30	0	0.00	1896	0.00	0	0.00	0	0.00	0	0.00	0	0.00	0	0.00	0	0.00	396.79	450.36	
Total Records		Control Total																																	
		6		2845.63																															

Points to Note: Control total of €2,845.63 agrees to net invoice amount (D4.1).
 Item highlighted in green will be identified by the Supplier as a designated dispute (D4.8).
 The above format is for illustration purposes.



DUoS Statement of Account
Date: 17/02/23 to 02/03/23

Supplier No: SXX
 Contract Account No: 116000000001
 Address: 1 Any Street, Any Town

Date	Ref No.	Description	Amount	Balance
			€	€
17/02/23		Opening balance		22,783.46
02/03/23		Payment	-22,283.91	499.55
02/03/23	900000000004	DUoS Charges for Current Billing Period	3,229.79	3,729.34
02/03/23		Closing balance		3,729.34
		Designated Disputes in Progress		-499.55
		Amount Due		3,229.79

Points to Note: The two designated disputes raised on invoice number 900000000003 are still in progress and are therefore deducted from the closing balance on the Supplier account to arrive at the amount due.



DUoS Charges - Dispute Summary

Date: 17/02/23 to 02/03/23

Supplier No: SXX
 Contract Account No: 116000000001
 Address: 1 Any Street, Any Town

Designated Disputes

Invoice Date	Invoice No.	Disputes In Progress	Disputes Accepted	Disputes Denied
		€	€	€
16/02/2023	900000000003	499.55		
Total		499.55	0.00	0.00

Resolved Amounts Now Due	0.00	0.00
---------------------------------	-------------	-------------

Non Designated Disputes

Invoice Date	Invoice No.	Disputes In Progress	Disputes Accepted	Disputes Denied
		€	€	€
Total		0.00	0.00	0.00

Points to Note: Summary shows that disputes on invoice number 900000000003 are still in progress.

DUoS Charges - Dispute Detail

Date: 17/02/23 to 02/03/23

Supplier No: SXX
 Contract Account No: 116000000001
 Address: 1 Any Street, Any Town

Invoice No.	Invoice Item No.	MPRN	Gross Amount	Dispute Type	Reason Code	Dispute Status	Raised On	Resolved On
900000000003	100000000023000101	10099983690	247.73	DD	SNR	In Progress	20/02/2023	
900000000003	100000000024000101	10099983691	251.82	DD	SNR	In Progress	21/02/2023	
Total Records	2							
End								

Points to Note: The dispute type is shown as DD (designated dispute). The reason code is also displayed for information purposes. As the status is In Progress, the Resolved On date is blank at this point in time.

Exhibit ID: D4.7

Remittance Advice						
<u>Current Inv. /Resolved</u>	<u>Invoice No.</u>	<u>MPRN</u>	<u>Invoice Item No.</u>	<u>Invoice Amount</u>	<u>Control Message Amount</u>	<u>Payment Amount</u>
<u>Desig. Dispute</u> C	900000000004	See MPRN Level Invoice Item Detail		3,229.79		3,229.79
Key:					EFT Value	3,229.79
Input by Supplier - All Other cells are locked						

Points to Note: This is the remittance advice as sent to the Supplier. The amount due for payment is as per invoice issued on 2nd March. Gross amount defaults into Payment Amount and EFT Amount.

The remittance advice as completed by the Supplier and returned to ESB Networks is displayed in D4.10.

Exhibit ID: D4.8

Header Level	Message Header	
Information – Level 1	Message Type	507
	Version number	01.00.00
	Time Stamp	2023-03-07-13-22-25
	Senders ID	SXX
	Recipient ID	DSO
	Transaction Reference number	A1140001
MPRN Level Information – Level 2	Meter Point Reference Number	10099983697
	Market Participant Business Reference	
	Invoice No	900000000004
	Invoice Item No	10000000031000101
	Dispute Reason	SNR
	Amount Disputed Total	
	Number of dispute records	

Points to Note: Using the data in the MPRN Level Invoice Item Detail (D4.3), the Supplier inserts MPRN, invoice number, invoice item number and dispute reason. In the example, a dispute reason of SNR is used as the Supplier is disputing registration of the MPRN.

Exhibit ID: D4.9

Header Level	Message Header	
Information – Level 1	Message Type	507C
	Version number	01.00.00
	Time Stamp	2023-03-15-10-25-25
	Senders ID	SXX
	Recipient ID	DSO
	Transaction Reference number	A1140001
MPRN Level Information – Level 2	Meter Point Reference Number	
	Market Participant Business Reference	
	Invoice No	900000000004
	Invoice Item No	
	Dispute Reason	
	Amount Disputed Total	290.74
	Number of dispute records	1

Points to Note: 507C message - one designated dispute on invoice in this scenario i.e. the Supplier has sent one 507 message to ESB Networks.

Exhibit ID: D4.10

Remittance Advice						
<u>Current Inv. /Resolved</u>	<u>Invoice No.</u>	<u>MPRN</u>	<u>Invoice Item No.</u>	<u>Invoice Amount</u>	<u>Control Message Amount</u>	<u>Payment Amount</u>
<u>Desig. Dispute</u> C	900000000004	See MPRN Invoice Item Detail		3,229.79	290.74	2,939.05
Key:					EFT Amount	2,939.05
Input by Supplier - All Other cells are locked						

Points to Note: This is the remittance advice as completed by the Supplier. The Supplier inserts the 507C message amount into the Control Message Amount cell, which automatically calculates the Payment Amount and EFT Amount. In the example, the Supplier is withholding payment of the gross amount of the designated dispute raised on the current invoice.



DUoS Supplier Invoice

Supplier No: SXX **Invoice No:** 900000000005
Date: 16/03/2023

Power Supply
1 Any Street
Any Town

Payment Enquiries to:
Billing & Income Office
ESB Networks Sarsfield Road Wilton,
Cork T12 E367

Description	Amount
DUoS Charges for Current Billing Periods	21,512.55
VAT @ 13.5%	2,904.19
Adjustment Debit Charges	109.35
VAT @ 13.5%	14.76
Total EUR	24,540.85

Payment terms: 10 Business Days

Due Date: 30/03/2023

All payments must be made by electronic transfer quoting the above invoice number to AIB A/c No. xxxxx xxxxx sort code xx-xx-xx. Payments of up to €1,270 can be made by cheque made payable to ESB Networks at the above address quoting the above invoice number.

Points to Note: Two net amounts on invoice, one for current charges and a second line relating to the re-invoiced amount for the accepted designated dispute, which was raised by the Supplier in scenario three on invoice item number 100000000023000101. The reversal of the original amount disputes is included in the credit note in D5.2.



DUoS Supplier Credit Note

Supplier No: SXX **Invoice No:** 900000000005
Date: 16/03/2023

Power Supply
1 Any Street
Any Town

Payment Enquiries to:
Billing & Income Office
ESB Networks Sarsfield Rd Wilton
Cork T12 E367

Description	Amount	
Adjustment Credit Charges	218.26	CR
VAT @ 13.5%	29.47	CR
Total EUR	247.73	CR

All payments must be made by electronic transfer quoting the above invoice number to AIB A/c No. xxxxx xxxxx sort code xx-xx-xx. Payments of up to €1,270 can be made by cheque made payable to ESB Networks at the above address quoting the above invoice number.

Points to Note: Adjustment credit relates to reversal of amount of accepted designated dispute.



DUoS Group Summary Report

Invoice No: 900000000005

Date: 15/03/2023

Supplier No: SXX

Time: 01.30.15

DUOS Group	Total Records	Day - TOU		Night - TOU		24hr - TOU		Reactive	Other Charges		Surcharges		Day Off Peak		Night Off Peak		Peak		QH Day Off Peak		QH Night Off Peak		QH Peak		Total Net New Charges	Adjustments				
		kWh	Charge	kWh	Charges	kWh	Charges		kVArh	Standing	Capacity	MIC	LPF	kWh	Charges	kWh	Charges	kWh	Charges	kWh	Charges	kWh	Charges	kWh		Charges	Credits	Debits		
DG1																														
DG2																														
DG3																														
DG4																														
DG5	4	6148	249.11	2932	14.54	5548	192.25	0	25.34	0	0	0.00	0	0.00	0	0.00	0	0.00	0	0.00	0	0.00	0	0.00	0	0.00	481.24	-218.26	109.35	
DG6	4	50034	1031.69	19217	46.12	0	0.00	11649	458.52	946.06	0.00	0.00	0	0.00	0	0.00	0	0.00	0	0.00	0	0.00	0	0.00	0	0.00	2482.39			
DG7	3	1281857	8306.44	547745	525.84	0	0.00	335952	566.67	6906.64	1670.24	218.01	0	0.00	0	0.00	0	0.00	3798	196.79	4659	28.46	2698	129.84	18548.92					
DG8																														
DG9																														
DG10																														
Grand Total	11	1338039	9587.24	569894	586.50	5548	192.25	347601	1050.53	7852.7	1670.2	218.01	0	0.00	0	0.00	0	0.00	3798	196.79	4659	28.46	2698	129.84	21512.55	-218.26	109.35			
																										Grand Total		21403.64		

Points to Note: Total of New Charges agrees to net invoice amount for current charges (D5.1).
 Total of Adjustment Credits agrees to net credit note amount (D5.2).
 Total of Adjustment Debits agrees to net adjustment debit amount (D5.1).
 The above format is for illustration purposes.

MPRN Invoice Item Detail

Invoice No. 900000000005
 Sender ID DSO
 Recipient ID SXX
 Time/ Date 15/03/2023

Invoice No.	Invoice Item No.	MPRN	Adj. Ref.	Invoice Type	Dub's Group	Billing Date From	Billing Date To	Day kWh Consumption	Day Energy Change	Night kWh Consumption	Night Energy Change	24 Hr kWh Consumption	24 Hr Energy Change	Standing Charge	Capacity Charge	MC	Max kVA	MC Surcharge	Reactive Energy kWh	Power Factor Surcharge	Day Off Peak kWh Consumption	Day Off Peak Energy Charge	Night Off Peak kWh Consumption	Night Off Peak Energy Charge	Peak kWh Consumption	Peak Energy Charge	QH Day Off Peak kWh Consumption	QH Day Off Peak Energy Charge	QH Night Off Peak kWh Consumption	QH Night Off Peak Energy Charge	QH Peak kWh Consumption	QH Peak Energy Charge	Net Amount	Gross Amount
900000000005	10000000041000101	10099983690	10000000023000101	25	DG5	01-Dec	02-Feb	-4724	-191.42	-2534	-12.57	0	0.00	-14.27	0.00	30	0	0.00	0	0.00	0	0.00	0	0.00	0	0.00	0	0.00	0	0.00	0	0.00	-218.26	-247.73
900000000005	100000000342000101	10099983690		35	DG5	01-Dec	02-Jan	2362	95.71	1267	6.28	0	0.00	7.36	0.00	30	0	0.00	0	0.00	0	0.00	0	0.00	0	0.00	0	0.00	0	0.00	0	0.00	109.35	124.11
900000000005	10000000043000101	10099983673		15	DG5	03-Jan	04-Mar	6148	249.11	2932	14.54	0	0.00	13.38	0.00	30	0	0.00	0	0.00	0	0.00	0	0.00	0	0.00	0	0.00	0	0.00	0	0.00	277.03	314.43
900000000005	10000000044000101	10099983674		15	DG5	04-Jan	05-Mar	0	0.00	0	0.00	5548	192.25	11.96	0.00	30	0	0.00	0	0.00	0	0.00	0	0.00	0	0.00	0	0.00	0	0.00	0	0.00	204.21	231.78
900000000005	10000000045000101	10099983675		15	DG6	05-Jan	06-Mar	25692	529.76	10187	24.45	0	0.00	114.63	344.02	80	0	0.00	4975	0.00	0	0.00	0	0.00	0	0.00	0	0.00	0	0.00	0	0.00	988.68	1122.15
900000000005	10000000046000101	10099983677		15	DG6	07-Jan	08-Mar	12882	265.63	5107	12.26	0	0.00	114.63	258.02	60	0	0.00	3598	0.00	0	0.00	0	0.00	0	0.00	0	0.00	0	0.00	0	0.00	650.54	738.36
900000000005	10000000047000101	10099983678		15	DG6	08-Jan	09-Mar	3567	73.56	793	1.90	0	0.00	114.63	215.01	50	0	0.00	872	0.00	0	0.00	0	0.00	0	0.00	0	0.00	0	0.00	0	0.00	405.10	459.79
900000000005	10000000048000101	10099983679		15	DG6	09-Jan	10-Mar	7893	162.74	3130	7.51	0	0.00	114.63	129.01	30	0	0.00	2204	0.00	0	0.00	0	0.00	0	0.00	0	0.00	0	0.00	0	0.00	413.89	469.77
900000000005	10000000049000101	10099983680		15	DG7	01-Feb	28-Feb	376840	2441.93	135055	129.65	0	0.00	188.89	1774.84	1305	1078	0.00	13335	0.00	0	0.00	0	0.00	0	0.00	953	49.38	978	5.97	756	36.38	4627.04	5251.69
900000000005	10000000050000101	10099983681		15	DG7	01-Feb	28-Feb	559043	3622.61	229060	219.89	0	0.00	188.89	3083.68	2250	2665	1694.42	309859	218.01	0	0.00	0	0.00	0	0.00	2059	106.68	2134	14.26	1125	54.14	9202.58	10444.93
900000000005	10000000051000101	10099983682		15	DG7	01-Feb	28-Feb	345974	2241.92	183630	176.28	0	0.00	188.89	2048.12	1500	1097	0.00	15758	0.00	0	0.00	0	0.00	0	0.00	786	40.73	1347	8.23	817	39.32	4743.48	5383.85
Total Records	Control Total															11																	21403.64	

Points to Note: Control total agrees to sum of net invoice and credit note amounts (D5.1 and D5.2).
 Item highlighted in red is reversal of designated dispute item.
 Item highlighted in blue in re-invoicing of designated dispute item.
 The above format is for illustration purposes.

**DUoS Statement of Account****Date: 03/03/23 to 16/03/23**

Supplier No: SXX
 Contract Account No: 116000000001
 Address: 1 Any Street, Any Town

Date	Ref No.	Description	Amount	Balance
			€	€
03/03/23		Opening balance		3,729.34
15/03/23		Payment	-2,939.05	790.29
16/03/23	900000000005	Adjustment Credit Charges	-247.73	542.56
16/03/23	900000000005	Adjustment Debit Charges	124.11	666.67
16/03/23	900000000005	DUoS Charges for Current Billing Period	24,416.74	25,083.41
16/03/23		Closing balance		25,083.41
		Designated Disputes in Progress		-290.74
		Amount Due		24,792.67

Points to Note: Designated dispute on invoice number 900000000004 is still in progress at this point in time and so is deducted from the closing balance on the Supplier account to give the amount due. The amount due from the Supplier is further explained in the remittance advice in D5.8.



DUoS Charges - Dispute Summary

Date: 03/03/23 to 16/03/23

Supplier No: SXX
 Contract Account No: 116000000001
 Address: 1 Any Street, Any Town

Designated Disputes

Invoice Date	Invoice No.	Disputes In Progress	Disputes Accepted	Disputes Denied
		€	€	€
16/02/2023	9000000000003		247.73	251.82
02/03/2023	9000000000004	290.74		
Total		290.74	247.73	251.82

Resolved Amounts Now Due	247.73	251.82
---------------------------------	---------------	---------------

Non Designated Disputes

Invoice Date	Invoice No.	Disputes In Progress	Disputes Accepted	Disputes Denied
		€	€	€
Total		0.00	0.00	0.00

Points to Note: Disputes have been raised on two invoices. The disputes on invoice number 9000000000003 have been resolved, one accepted and the other denied. The dispute on invoice number 9000000000004 is still in progress at this point in time.

Exhibit ID: D5.7

DUoS Charges - Dispute Detail

Date: 03/03/23 to 16/03/23

Supplier No: SXX
Contract Account No: 116000000001
Address: 1 Any Street, Any Town

Invoice No.	Invoice Item No.	MPRN	Gross Amount	Dispute Type	Reason Code	Dispute Status	Raised On	Resolved On
900000000003	100000000023000101	10099983690	247.73	DD	SNR	Accepted	20/02/2023	04/03/2023
900000000003	100000000024000101	10099983691	251.82	DD	SNR	Denied	21/02/2023	05/03/2023
900000000004	100000000031000101	10099983697	290.74	DD	SNR	In Progress	07/03/2023	
Total Records	3							
End								

Points to Note: The report now shows that the two disputes on invoice number 900000000003 have been resolved – one accepted, one denied. The one dispute on invoice number 900000000004 is still in progress at this point in time.

Remittance Advice							
<u>Current Inv. /Resolved</u>	<u>Desig. Dispute</u>	<u>Invoice No.</u>	<u>MPRN</u>	<u>Invoice Item No.</u>	<u>Invoice Amount</u>	<u>Control Message Amount</u>	<u>Payment Amount</u>
	C	900000000005	See MPRN Invoice Item Detail		24,293.12		24,293.12
	R	900000000003	See Dispute Detail File		499.55		499.55
Key:						EFT Amount	24,792.67
Input by Supplier - All Other cells are locked							

Points to Note: This is the remittance advice as sent to the Supplier. The amount due for payment relates to 3 items – (1) the net amount of the current invoice and credit note, (2) the accepted designated dispute and (3) the denied designated dispute. The remittance advice shows the original amount of the disputes as due for payment. For the denied designated dispute this is because the original amount was withheld by the Supplier and is now due for payment as the dispute is resolved.

In the case of the accepted designated dispute, the remittance advice also lists the original amount as due for payment. However the current amount due of €24,293.12 includes a reversal of accepted dispute amount (i.e. the credit note) and a re-invoiced amount (i.e. the adjustment debit charge on the invoice). Therefore the Supplier is paying:

Current DUoS Charges	€24,416.74
Re-invoiced Amount for Accepted Designated Dispute	€124.11
Credit Note for Accepted Designated Dispute	€247.73
Original Value of Accepted Designated Dispute	€247.73
Original Value of Denied Designated Dispute	€251.82
As per EFT amount	24,792.67

Exhibit ID: D5.9

Header Level	Message Header	
Information – Level 1	Message Type	507C
	Version number	01.00.00
	Time Stamp	2023-03-29-14-38-25
	Senders ID	SXX
	Recipient ID	DSO
	Transaction Reference number	A1150001
MPRN Level		
Information – Level 2	Meter Point Reference Number	
	Market Participant Business Reference	
	Invoice No	900000000005
	Invoice Item No	
	Dispute Reason	
	Amount Disputed Total	0
	Number of dispute records	0

Points to Note: 507C message - no designated disputes raised on the current invoice in this scenario.

Exhibit ID: D5.10

Remittance Advice

<u>Current Inv. /Resolved</u>	<u>Invoice No.</u>	<u>MPRN</u>	<u>Invoice Item No.</u>	<u>Invoice Amount</u>	<u>Control Message Amount</u>	<u>Payment Amount</u>
<u>Desig. Dispute</u>						
C	900000000005	See MPRN Invoice Item Detail		24,293.12	0.00	24,293.12
R	900000000003	See Dispute Detail File		455.99		499.55

Key:

EFT Amount

24,792.67

Input by Supplier - All Other cells are locked

Points to Note: This is the remittance advice as completed by the Supplier. The Supplier inserts the 507C message amount into the Control Message Amount cell, which automatically calculates the Payment and EFT Amounts.

7 Transaction Invoicing, Payments and Disputes – Documentation

7.1 Overview

This section contains the documentation that a Supplier will receive from ESB Networks and the documentation that must be returned to ESB Networks over the course of a number of Transaction invoicing scenarios. The purpose of the scenarios is to illustrate how the regular cyclical invoicing and payment process will work in possible scenarios.

Four scenarios of Transaction invoicing will be demonstrated. The events occurring in each scenario will be referenced to the relevant steps in MPD 34 and to sample formats of the relevant documentation. The four scenarios are as follows:

Scenario	Invoice Date	Timeframe	Scenario Feature
One	2 February	2 Feb – 1 Mar	Non-designated dispute accepted
Two	2 March	2 Mar – 3 Apr	Two designated disputes raised
Three	4 April	4 Apr – 2 May	Designated disputes – one raised, two in progress
Four	3 May	3 May – 1 Jun	Designated disputes – one accepted, one denied, one in progress

As indicated in the above table, a scenario will cover the period of time from the issue of the current invoice to the issue of next invoice.

Note

- **Dates, document numbers (i.e. invoice numbers etc) and monetary amounts are for illustrative purposes only.**
- **Volumes and types of consumption data are simplified to aid comprehension and are not intended to be representative of a typical Supplier.**
- **Template designs are subject to change.**
- **The example Scenarios are for illustrative purposes only and do not preclude ESB Networks from following up for payments of overdue items outside of this regular process.**

7.2 Scenario One

The sequence of events in Scenario One is as follows:

Role	Description	Exhibit ID	MPD Step
N	Transaction invoice is created to include all service requests completed during the month (example, 1 st to 31 st January).		1
N	All relevant invoicing documentation is issued to Supplier via SFTS / EE on 2 nd February.	T1.1 to T1.5	2
S	Supplier receives documentation and validates amount due to ESB Networks.		3
S	Supplier notifies ESB Networks that there is one invoice item in dispute and that the dispute type is <i>non-designated</i> .	Highlighted in T1.2.	4,5,15
S	As there are no further disputes, the Supplier sends a 507C control message to ESB Networks indicating that gross amount and number of <i>designated disputes</i> are nil.	T1.6	11,12
S	Supplier updates the remittance advice by inserting the 507C message amount (in this case €0.00) and returns the advice to ESB Networks.	T1.7	14
S	Supplier makes full payment for amount due via EFT on due date, which in the example has been calculated as 16 th February.		22
N	ESB Networks receives and ensures that the 507C message, remittance advice and EFT amounts reconcile.		13, 21,23,24, 25
N	ESB Networks processes the payment against the Supplier account.		26
N	ESB Networks investigates the non-designated dispute and resolves it in favour of the Supplier.		17
N/S	ESB Networks confirms resolution of the dispute with the Supplier.		29/30
N	ESB Networks performs necessary invoicing adjustments to reflect resolution of the dispute i.e. original disputed amount is reversed and correct amount is re-invoiced. These adjustments will be reflected in the Scenario two documentation.		31

N = ESB Networks; S = Supplier

Key points or features are noted below each exhibit.

7.3 Scenario Two

The sequence of events in Scenario Two is as follows:

Role	Description	Exhibit ID	MPD Step
N	Transaction invoice is created to include all service requests completed during the month (example, 1 st to 28 th February) and corrected charge for accepted non-designated dispute. Credit note is created for reversal of original amount of dispute.		1
N	All relevant invoicing documentation is issued to Supplier via SFTS / EE on 2 nd March.	T2.1 to T2.7	2
S	Supplier receives documentation and validates amount due to ESB Networks.		3
S	Supplier identifies two designated disputes on the current invoice. The registration of the MPRN is being challenged in both cases.	Highlighted in T2.3.	4,5
S	The Supplier sends a 507 message for <u>each</u> designated dispute.	T2.8,T2.9	6
S	As there are no further disputes, the Supplier sends a 507C control message to ESB Networks indicating the gross amount of designated disputes as €372.28 and the number as two.	T2.10	12
S	Supplier updates the remittance advice by inserting the 507C message amount of €372.28 and returns the advice to ESB Networks.	T2.11	14
S	Supplier pays the amount due via EFT on due date, which in the example has been calculated as 16 th March.		22
N	ESB Networks receives and confirms that the 507C message, remittance advice and EFT amounts reconcile.		13, 21, 23, 24, 25
N	ESB Networks processes the payment against the Supplier account.		26
N	ESB Networks investigates the two designated disputes. In the example, it is assumed that the disputes are not resolved before commencement of Scenario three.		17

N = ESB Networks; S = Supplier

Key points or features are noted below each exhibit.

7.4 Scenario Three

The sequence of events in Scenario Three is as follows:

Role	Description	Exhibit ID	MPD Step
N	Transaction invoice is created to include all service requests completed during the month (example, 1 st to 31 st March).		1
N	All relevant invoicing documentation is issued to Supplier via SFTS / EE on 4 th April.	T3.1 to T3.6	2
S	Supplier receives documentation and validates amount due to ESB Networks.		3
S	Supplier identifies one designated dispute on the current invoice. The registration of the MPRN is being challenged.	Highlighted in T3.2.	4,5
S	The Supplier sends a 507 message for the designated dispute.	T3.7	6
S	As there are no further disputes, the Supplier sends a 507C control message to ESB Networks indicating that the gross amount of designated disputes as €120.31 and the number as one.	T3.8	12
S	Supplier updates the remittance advice by inserting the 507C message amount of €120.31 and returns the advice to ESB Networks.	T3.9	14
S	Supplier pays the amount due via EFT on due date, which in the example has been calculated as 18 th April.		22
N	ESB Networks receives and confirms that the 507C message, remittance advice and EFT amounts reconcile.		13, 21, 23, 24, 25
N	ESB Networks processes the payment against the Supplier account.		26
N	ESB Networks investigates the current designated dispute In the example, it is assumed that this dispute is not resolved before the commencement of Scenario four.		17
N/S	ESB Networks reaches a resolution on the two designated disputes raised on invoice number 900000623. One dispute is accepted, the other denied. ESB Networks confirms this with the Supplier		29, 30
N	ESB Networks performs necessary invoicing adjustments to reflect resolution of the accepted dispute i.e. the original disputed amount is reversed. No amount is re-invoiced as the MPRN is not registered with the Supplier and therefore the charge does not apply. These adjustments will be reflected in the Scenario four documentation.		31

N = ESB Networks; S = Supplier

Key points or features are noted below each exhibit.

7.5 Scenario Four

The sequence of events in Scenario Four is as follows:

Role	Description	Exhibit ID	MPD Step
N	Transaction invoice is created to include all service requests completed during the month (example, 1 st to 29 th April). A credit note is created for reversal of original amount of accepted designated dispute.		1
N	All relevant invoicing documentation is issued to Supplier via SFTS / EE on 3 rd May.	T4.1 to T4.7	2
S	Supplier receives documentation and validates amount due to ESB Networks.		3
S	Supplier decides that there are no invoice items in dispute.		4,11
S	Supplier sends a 507C control message to ESB Networks indicating that the gross amount and number of designated disputes are nil.	T4.8	12
S	Supplier updates the remittance advice by inserting the 507C message amount (in this case €0.00) and returns the advice to ESB Networks.	T4.9	14
S	Supplier pays the amount due via EFT on due date, which in the example has been calculated as 17 th May.		22
N	ESB Networks receives and ensures that the 507C message, remittance advice and EFT amounts reconcile.		13, 21, 23, 24, 25
N	ESB Networks processes the payment against the Supplier account.		26
N	ESB Networks is continuing to investigate the designated dispute on invoice number 900000675. In the example, it is assumed that the dispute is not resolved for the commencement of the next Scenario.		17

N = ESB Networks; S = Supplier

Key points or features are noted below each exhibit.

7.6 Transaction Exhibits

Exhibit ID	Exhibit Name	Page
Scenario One		
T1.1	Invoice	78
T1.2	Detailed Transaction Charges	79
T1.3	Account Statement	80
T1.4	Dispute Summary	81
T1.5	Remittance Advice sent to Supplier	82
T1.6	507C Control Market Message	83
T1.7	Remittance Advice returned by Supplier	84
Scenario Two		
T2.1	Invoice	85
T2.2	Credit Note	86
T2.3a	Detailed Transaction Charges (debit charges)	87
T2.3b	Detailed Transaction Charges (credit charges)	87
T2.4	Account Statement	88
T2.5	Dispute Summary	89
T2.6	Dispute Detail	90
T2.7	Remittance Advice sent to Supplier	91
T2.8	507 Market Message	92
T2.9	507 Market Message	92
T2.10	507C Control Market Message	93
T2.11	Remittance Advice returned by Supplier	94
Scenario Three		
T3.1	Invoice	95
T3.2	Detailed Transaction Charges	96
T3.3	Account Statement	97
T3.4	Dispute Summary	98
T3.5	Dispute Detail	99
T3.6	Remittance Advice sent to Supplier	100
T3.7	507 Market Message	101
T3.8	507C Control Market Message	102
T3.9	Remittance Advice returned by Supplier	103
Scenario Four		
T4.1	Invoice	104
T4.2	Credit Note	106
T4.3a	Detailed Transaction Charges	107
T4.3b	Detailed Transaction Charges	107
T4.4	Account Statement	109
T4.5	Dispute Summary	110
T4.6	Dispute Detail	111
T4.7	Remittance Advice sent to Supplier	112
T4.8	507C Control Market Message	113
T4.9	Remittance Advice returned by Supplier	114

Exhibit ID:



Supplier No:
SXX

Invoice No:
900000567

Power Supply
1 Any Street
Any Town
Ireland

Payment Enquiries to:
Billing & Income Office
ESB Networks Sarsfield Rd Wilton
Cork T12 E367
Telephone No: 1850200810

Document Type: Invoice

Date: 02/02/2005

Description	Amount
Transaction Charges from 01/01/2005 to 31/01/2005	900.00
VAT @ 13.5%	121.52
Total EUR	1,021.52

Payment terms: 10 Business Days

Due Date: 16/02/2005

All payments must be made by electronic transfer quoting the above invoice number to AIB A/c No. xxxxx xxxxx sort code xx-xx-xx. Payments of up to €1,270 can be made by cheque made payable to ESB Networks at the above address quoting the above invoice number.

Contract Account No	Invoice No	Total
116000000003	900000567	1,021.52



Exhibit ID: T1.2

Invoice No.	900000567
From Date	01.01.2005
To Date	31.01.2005
Sender ID	DSO
Recipient ID	SXX
Time/Date	02/02/2005

Invoice Item No	Market Participant Business Reference	Transaction Description	MPRN	Net Amount	VAT Amount	Gross Amount
3200000205	A5559777	Re-energise	10000000111	93.00	12.56	105.56
3200000204	A5559776	MD Read and Reset	10000000124	133.00	17.96	150.96
3200000203	A5559774	Check Reading	10000000150	80.00	10.80	90.80
3200000202	A5556662	Major Meter Test	10000000151	239.00	32.27	271.27
3200000195	A5556987	De-energise	10000005621	93.00	12.56	105.56
3200000185	A5556347	Exch. from ST to D/T	10000032145	262.00	35.37	297.37

Total Records	6
Control Total	1021.52
End of File	

Points to Note:

- (1) Control total of €1,021.52 agrees to gross invoice amount (T1.1).
- (2) Sum of net amounts agrees to net invoice amount (T1.1).
- (3) The above exhibit is for illustration purposes only. The flat file will not contain any row headings etc. Section 9 of this document contains guidelines for using this flat file.
- (4) The Market Participant Business Reference may be quoted by the Supplier upon requesting the service. Otherwise the field will remain blank.
- (5) The recipient ID is the same as the Supplier Number, in the example SXX.
- (6) The item highlighted in green is the non-designated dispute raised by the Supplier.



Transaction Statement of Account

Date: 01/01/05 to 02/02/05

Supplier No: SXX
 Contract Account No: 116000000003
 Address: 1 Any Street, Any Town

Date	Ref No.	Description	Amount	Balance
			€	€
01/01/05		Opening balance		0.00
02/02/05	900000567	Transaction Charges for Current Period	1,021.52	1,021.52
02/02/05		Closing balance		1,021.52
		Designated Disputes in Progress		0.00
		Amount Due		1,021.52

Points to Note: Only movement on Supplier account in period is issue of invoice by ESB Networks on 2nd February.

Contract account number indicates the account type, in the example, the Supplier Transaction Account.



Transaction Charges - Dispute Summary

Date: 01/01/05 to 02/02/05

Supplier No: SXX
 Contract Account No: 116000000003
 Address: 1 Any Street, Any Town

Designated Disputes

Invoice Date	Invoice No.	Disputes In Progress €	Disputes Accepted €	Disputes Denied €
Total		0.00	0.00	0.00

Resolved Amounts Now Due	0.00	0.00
---------------------------------	-------------	-------------

Non Designated Disputes

Invoice Date	Invoice No.	Disputes In Progress €	Disputes Accepted €	Disputes Denied €
Total		0.00	0.00	0.00

Points to Note: No details reported for Scenario one as no disputes in progress or resolved during the period covered by the summary.

Exhibit ID: T1.5

Remittance Advice						
<u>Current Inv (C) /Resolved Desig. Dispute (R)</u>	<u>Invoice No.</u>	<u>MPRN</u>	<u>Invoice Item No</u>	<u>Invoice Amount</u>	<u>Control Message Amount</u>	<u>Payment Amount</u>
C	900000567	See Detailed Transaction Charges		1,021.52		1,021.52
Key:					EFT Amount	1,021.52
Input by Supplier - All Other cells are locked						

Points to Note: This is the remittance as sent to the Supplier for completion. Amount due for payment is as per invoice issued on 2nd February. Gross invoice amount defaults into Payment Amount and EFT Amount.

The remittance advice as completed by the Supplier and returned to ESB Networks is displayed in T1.7.

Exhibit ID: T1.6

Header Level	Message Header	
Information – Level 1	Message Type	507C
	Version number	01.00.00
	Time Stamp	2005-02-14-12-45-10
	Senders ID	SXX
	Recipient ID	DSO
	Transaction Reference number	A2010001
MPRN Level		
Information – Level 2	Meter Point Reference Number	
	Market Participant Business Reference	
	Invoice No	900000567
	Invoice Item No	
	Dispute Reason	
	Amount Disputed Total	0
	Number of dispute records	0

Points to Note: 507C message - no designated disputes on the current invoice in this Scenario i.e. the Supplier has raised no 507 messages on the current invoice.

Guidelines for sending 507C messages are included in Market Message Implementation Guide – Common Data Segments and Market Message Implementation Guide – DUoS and Transaction Payments.

Exhibit ID: T1.7

Remittance Advice						
<u>Current Inv (C) /Resolved Desig. Dispute (R)</u>	<u>Invoice No.</u>	<u>MPRN</u>	<u>Invoice Item No</u>	<u>Invoice Amount</u>	<u>Control Message Amount</u>	<u>Payment Amount</u>
C	900000567	See Detailed Transaction Charges		1,021.52	0.00	1,021.52
Key:					EFT Amount	1,021.52
Input by Supplier - All Other cells are locked						

Points to Note: This is the remittance advice as completed by the Supplier. The Supplier inserts 507C message amount into Control Message Amount cell, which automatically calculates Payment and EFT Amounts.



Supplier No:
SXX

Invoice No:
900000623

Power Supply
1 Any Street
Any Town
Ireland

Payment Enquiries to:
Billing & Income Office
ESB Networks Sarsfield Rd Wilton
Cork T12 E367
Telephone No: 1850200810

Document Type: Invoice

Date: 02/03/2005

Description	Amount
Transaction Charges from 01/02/2005 to 28/02/2005	1,860.00
VAT @ 13.5%	251.11
Total EUR	2,111.11

Payment terms: 10 Business Days

Due Date: 16/03/2005

All payments must be made by electronic transfer quoting above the above invoice number to AIB A/c No. xxxxxx xxxxxx sort code xx-xx-xx. Payments of up to €1,270 can be made by cheque made payable to ESB Networks at the above address quoting the above invoice number.

Contract Account No	Invoice No	Total
116000000003	900000623	2,111.11



Points to Note: Net amount includes re-invoiced amount for accepted non-designated dispute raised by the Supplier in Scenario one on invoice item number 3200000195. The reversal of the original amount charged is included in the credit note in T2.2.



Supplier No:
SXX

Invoice No:
900000624

Power Supply
1 Any Street
Any Town
Ireland

Payment Enquiries to:
Billing & Income Office
ESB Networks Sarsfield Rd Wilton
Cork T12 E367
Telephone No: 1850200810

Document Type: Credit Note

Date: 02/03/2005

Description	Amount
Credits for Paid Items	93.00 CR
VAT @ 13.5%	12.56 CR
Total EUR	105.56 CR

All payments must be made by electronic transfer quoting the above invoice number to AIB A/c No. xxxxx xxxxx sort code xx-xx-xx. Payments of up to €1,270 can be made by cheque made payable to ESB Networks at the above address quoting the above invoice number.

Contract Account No	Invoice No	Total
1160000000003	900000624	105.56 CR



Points to Note: Adjustment credit relates to reversal of original amount of accepted non-designated dispute raised by the Supplier in Scenario one on invoice item number 3200000195.

Exhibit ID: T2.3a

Invoice No. 90000623
From Date 01.02.2005
To Date 28.02.2005
Sender ID DSO
Recipient ID SXX
Time/Date 02/03/2005

Detailed Transaction Charges

Invoice Item No	Market Participant Business Reference	Transaction Description	MPRN	Net Amount	VAT Amount	Gross Amount
320000400	A5556987	Check Reading	1000005621	80.00	10.80	90.80
320000401	A5556222	Remove NSH MT and T/S	1000056322	171.00	23.09	194.09
320000422	A5556226	Exch from F.R. to MD	1000000006	632.00	85.32	717.32
320000426	A5556224	Exch MD for MD + SGNLS	1000004269	649.00	87.62	736.62
320000498	A5556662	Inst signals ext MFM	10000639584	170.00	22.95	192.95
320000523	A5556682	Install NSH MT & T/S	1000003639	158.00	21.33	179.33
Total Records	6					
Control Total	2111.11					
End of File						

Exhibit ID: T2.3b

Invoice No. 90000624
From Date 01.02.2005
To Date 28.02.2005
Sender ID DSO
Recipient ID SXX
Time/Date 02/03/2005

Detailed Transaction Charges

Invoice Item No	Market Participant Business Reference	Transaction Description	MPRN	Net Amount	VAT Amount	Gross Amount
220000015	A5556987	De-energise	1000005621	-93.00	-12.56	-105.56
Total Records	1					
Control Total	-105.56					
End of File						

Points to Note:

Control totals agree to gross invoice and credit note amounts (T2.1 and T2.2).
 Item highlighted in blue is re-invoicing of accepted non-designated dispute.
 Item highlighted in red is reversal of original amount of accepted non-designated dispute.
 Items highlighted in green are identified by the Supplier as designated disputes (T2.8 and T2.9).

Transaction Statement of Account
Date: 03/02/05 to 02/03/05

Supplier No: SXX
 Contract Account No: 116000000003
 Address: 1 Any Street, Any Town

Date	Ref No.	Description	Amount	Balance
			€	€
03/02/05		Opening balance		1,021.52
16/02/05		Payment	-1,021.52	0.00
02/03/05	900000624	Adjustment Credit Charges	-105.56	-105.56
02/03/05	900000623	Transaction Charges for Current Period	2,111.11	2,005.55
02/03/05		Closing balance		2,005.55
		Designated Disputes in Progress		0.00
		Amount Due		2,005.55

Points to Note: Account statement shows credit note for accepted designated dispute and invoice (which incorporates charges for current period plus re-invoiced charge for accepted designated dispute).



Transaction Charges - Dispute Summary

Date: 03/02/05 to 02/03/05

Supplier No: SXX
 Contract Account No: 116000000003
 Address: 1 Any Street, Any Town

Designated Disputes

Invoice Date	Invoice No.	Disputes In Progress €	Disputes Accepted €	Disputes Denied €
Total		0.00	0.00	0.00

Resolved Amounts Now Due	0.00	0.00
---------------------------------	-------------	-------------

Non Designated Disputes

Invoice Date	Invoice No.	Disputes In Progress €	Disputes Accepted €	Disputes Denied €
02/02/2005	900000567		105.56	
Total		0.00	105.56	0.00

Points to Note: Report now shows that disputes on invoice number 900000567 were resolved during the period and were accepted in favour of the Supplier.

Exhibit ID: T2.6

**Transaction Charges - Dispute
Detail**

Date: 03/02/05 to 02/03/05

Supplier No: SXX
Contract Account No: 116000000003
Address: 1 Any Street, Any Town

Invoice No	Invoice Item No	MPRN	Market Participant Business Reference	Amount	Dispute Type	Reason Code	Dispute Status	Raised On	Resolved On
900000567	3200000195	10000005621	A5556987	105.56	ND		Accepted	09/02/2005	20/02/2005
Total Records	1								
End									

Points to Note: Report shows that there was one disputed item on invoice number 900000567, the dispute type as ND for non-designated, the status as accepted and the dates on which the dispute was notified to and resolved by ESB Networks. The Market Participant Business Reference is as quoted by the Supplier upon requesting the service and when disputing the invoice item.

Guidelines for using this flat file are contained in Section 9 of this document.

Exhibit ID: T2.7

Remittance Advice

<u>Current Inv (C) /Resolved</u>	<u>Invoice No.</u>	<u>MPRN</u>	<u>Invoice Item No</u>	<u>Invoice Amount</u>	<u>Control Message Amount</u>	<u>Payment Amount</u>
<u>Desig. Dispute (R)</u>						
C	900000623	See Detailed Transaction Charges		2,111.11		2,111.11
C	900000624	See Dispute Detail File		-105.56		-105.56

Key:

EFT Amount

2,005.55

Input by Supplier - All Other cells are locked

Points to Note: This is the remittance advice as sent to the Supplier. Amount due for payment is invoice issued on 2nd March. Gross invoice amount defaults into Payment Amount and EFT Amount.

The remittance advice as completed by the Supplier and returned to ESB Networks is displayed in T2.11.

Exhibit ID: T2.8

Header Level	Message Header	
Information – Level 1	Message Type	507
	Version number	01.00.00
	Time Stamp	2005-03-07-16-42-10
	Senders ID	SXX
	Recipient ID	DSO
	Transaction Reference number	A2020001
MPRN Level		
Information – Level 2	Meter Point Reference Number	10000639584
	Market Participant Business Reference	A5556662
	Invoice No	900000623
	Invoice Item No	3200000498
	Dispute Reason	SNR
	Amount Disputed Total	
	Number of dispute records	

Exhibit ID: T2.9

Header Level	Message Header	
Information – Level 1	Message Type	507
	Version number	01.00.00
	Time Stamp	2005-03-08-15-25-45
	Senders ID	SXX
	Recipient ID	DSO
	Transaction Reference number	A2020002
MPRN Level		
Information – Level 2	Meter Point Reference Number	10000003639
	Market Participant Business Reference	A5556682
	Invoice No	900000623
	Invoice Item No	3200000523
	Dispute Reason	SNR
	Amount Disputed Total	
	Number of dispute records	

Points to Note: Using the data in the Detailed Transaction Charges file (T2.3a), the Supplier inserts MPRN, invoice number, invoice item number and dispute reason. In the example, a dispute reason of SNR is used as the Supplier is disputing registration of the MPRN's.

The Supplier may also include the Market Participant Business Reference quoted when originally requesting the service.

Guidelines for sending 507 messages are included in Market Message Implementation Guide – Common Data Segments and Market Message Implementation Guide – DUoS and Transaction Payments.

Exhibit ID: T2.10

Header Level	Message Header	
Information – Level 1	Message Type	507C
	Version number	01.00.00
	Time Stamp	2005-03-15-16-05-45
	Senders ID	SXX
	Recipient ID	DSO
	Transaction Reference number	A2020003
MPRN Level Information – Level 2	Meter Point Reference Number	
	Market Participant Business Reference	
	Invoice No	900000623
	Invoice Item No	
	Dispute Reason	
	Amount Disputed Total	372.28
	Number of dispute records	2

Points to Note: 507C message - the Supplier has raised two designated disputes on the current invoice in this Scenario i.e. the Supplier has raised two 507 messages.

Exhibit ID: T2.11

Remittance Advice

Current Inv (C)
/Resolved Desig.
Dispute (R)

Invoice No.
900000623
900000624

MPRN Invoice Item No
See Detailed Transaction Charges
See Dispute Detail File

Invoice Amount
2,111.11
-105.56

Control Message Amount
372.28

Payment Amount
1,738.83
-105.56

Key:

EFT Amount

1,633.27

Input by Supplier - All Other cells are
locked

Points to Note: This is the remittance advice as completed by the Supplier. The Supplier inserts 507C message amount into Control Message Amount cell, which automatically calculates the Payment Amount and EFT Amount. In the example, the Supplier is withholding payment of the gross amount of the two designated disputes raised on the current invoice.



Supplier No:
SXX

Invoice No:
900000675

Power Supply
1 Any Street
Any Town
Ireland

Payment Enquiries to:
Billing & Income Office
ESB Networks Sarsfield Road Wilton,
Cork T12 E367
Telephone No: 1850200810

Document Type: Invoice

Date: 04/04/2005

Description	Amount
Transaction Charges from 01/03/2005 to 31/03/2005	477.00
VAT @ 13.5%	64.41
Total EUR	541.41

Payment terms: 10 Business Days

Due Date: 18/04/2005

All payments must be made by electronic transfer quoting the above invoice number to AIB A/c No. xxxxx xxxxx sort code xx-xx-xx. Payments of up to €1,270 can be made by cheque made payable to ESB Networks at the above address quoting the above invoice number.

Contract Account No	Invoice No	Total
116000000003	900000675	541.41



Exhibit ID: T3.2

Detailed Transaction Charges						
Invoice No.	900000675					
From Date	01.03.2005					
To Date	31.03.2005					
Sender ID	DSO					
Recipient ID	SXX					
Time/Date	04/04/2005					
	Market Participant Business Reference	Transaction Description	MPRN	Net Amount	VAT Amount	Gross Amount
Invoice Item No						
3200000550	A5559333	MD Read and Reset	10000005697	185.00	24.98	209.98
3200000551	A5559336	Re-energise	10000066555	93.00	12.56	105.56
3200000556	A5559334	Check Reading	10012336669	106.00	14.31	120.31
3200000560	A5556662	De-energise	10090000002	93.00	12.56	105.56
Total Records	4					
Control Total	541.41					
End of File						

*Points to Note: Control total of €541.41 agrees to gross invoice amount (T3.1).
Item highlighted in green is designated dispute raised by the Supplier (T3.7).*



Transaction Statement of Account

Date: 03/03/05 to 04/04/05

Supplier No: SXX
 Contract Account No: 116000000003
 Address: 1 Any Street, Any Town

Date	Ref No.	Description	Amount	Balance
			€	€
03/03/05		Opening balance		2,005.55
16/03/05		Payment	-1,633.27	372.28
04/04/05	900000675	Transaction Charges for Current Period	541.41	913.69
04/04/05		Closing balance		913.69
		Designated Disputes in Progress		-372.28
		Amount Due		541.41

Points to Note: Designated disputes on invoice number 900000623 are still in progress at this point in time and are deducted from the closing balance on the Supplier account to give the amount due for payment.



Transaction Charges - Dispute Summary

Date: 03/03/05 to 04/04/05

Supplier No: SXX
 Contract Account No: 116000000003
 Address: 1 Any Street, Any Town

Designated Disputes

Invoice Date	Invoice No.	Disputes In Progress	Disputes Accepted	Disputes Denied
		€	€	€
02/32/2005	900000623	372.28		
Total		372.28	0.00	0.00

Resolved Amounts Now Due	0.00	0.00
---------------------------------	-------------	-------------

Non Designated Disputes

Invoice Date	Invoice No.	Disputes In Progress	Disputes Accepted	Disputes Denied
		€	€	€
Total		0.00	0.00	0.00

Points to Note: Disputes on invoice number 900000623 are still in progress.

Exhibit ID: T3.5

**Transaction Charges - Dispute
Detail**

Date: 03/03/05 to 04/04/05

Supplier No: SXX
Contract Account No: 116000000003
Address: 1 Any Street, Any Town

Invoice No	Invoice Item No	MPRN	Market Participant Business Reference	Amount	Dispute Type	Reason Code	Dispute Status	Raised On	Resolved On
900000623	3200000498	10000639584	A5556662	192.95	DD	SNR	In Progress	07/03/2005	
900000623	3200000523	10000003639	A5556682	179.33	DD	SNR	In Progress	08/03/2005	
Total Records	2								
End									

Points to Note: The dispute is shown as DD (designated dispute). The reason code is also displayed for information purposes. As the status is In Progress, the Resolved On date is blank at this point in time.

Exhibit ID: T3.6

Remittance Advice						
<u>Current Inv (C)</u> <u>/Resolved Desig.</u> <u>Dispute (R)</u>	<u>Invoice No.</u>	<u>MPRN</u>	<u>Invoice Item No</u>	<u>Invoice Amount</u>	<u>Control Message Amount</u>	<u>Payment Amount</u>
C	900000675	See Detailed Transaction Charges		541.41		541.41
Key:					EFT Amount	541.41
Input by Supplier - All Other cells are locked						

Points to Note: This is the remittance advice as sent to the Supplier. Amount due for payment is as per invoice issued on 4th April. Gross amount defaults into Payment Amount and EFT Amount.

The remittance advice as completed by the Supplier and returned to ESB Networks is displayed in T3.9.

Exhibit ID: T3.7

Header Level	Message Header	
Information – Level 1	Message Type	507
	Version number	01.00.00
	Time Stamp	2005-04-15-15-07-42
	Senders ID	SXX
	Recipient ID	DSO
	Transaction Reference number	A2030001
MPRN Level		
Information – Level 2	Meter Point Reference Number	10012336669
	Market Participant Business Reference	A5559334
	Invoice No	900000675
	Invoice Item No	3200000556
	Dispute Reason	SNR
	Amount Disputed Total	
	Number of dispute records	

Points to Note: Using data in the Detailed Transaction Charges file (T3.2), the Supplier inserts MPRN, invoice number, invoice item number and dispute reason. In the example, a dispute reason of SNR is used as the Supplier is disputing registration of the MPRN.

Exhibit ID: T3.8

Header Level	Message Header	
Information – Level 1	Message Type	507C
	Version number	01.00.00
	Time Stamp	2005-04-15-16-35-20
	Senders ID	SXX
	Recipient ID	DSO
	Transaction Reference number	A2030002
MPRN Level		
Information – Level 2	Meter Point Reference Number	
	Market Participant Business Reference	
	Invoice No	900000675
	Invoice Item No	
	Dispute Reason	
	Amount Disputed Total	120.31
	Number of dispute records	1

Points to Note: 507C message indicates the number and gross amount of designated disputes raised on the current invoice i.e. the Supplier has raised two 507 messages.

Exhibit ID: T3.9

Remittance Advice

Current Inv (C)
/Resolved Desig.
Dispute (R)
C

Invoice No.
900000675

MPRN
See Detailed Transaction Charges

Invoice Item No

Invoice Amount
541.41

Control Message Amount
120.31

Payment Amount
421.10

Key:

EFT Amount

421.10

Input by Supplier - All Other cells are locked

Points to Note: This is the remittance advice as completed by the Supplier. The Supplier inserts 507C message amount into Control Message Amount cell, which automatically calculates the Payment and EFT Amounts. In the example the Supplier is withholding payment of the gross amount of the designated dispute raised on the current invoice.



Supplier No:
SXX

Invoice No:
900000702

Power Supply
1 Any Street
Any Town
Ireland

Payment Enquiries to:
Billing & Income Office
ESB Networks Sarsfield Rd Wilton
Cork T12 E367
Telephone No:
1850200810

Document Type: Invoice

Date: 03/05/2005

Description	Amount
Transaction Charges from 01/04/2005 to 29/04/2005	1,426.00
VAT @ 13.5%	192.53
Total EUR	1,618.53

Payment terms: 10 Business Days

Due Date: 17/05/2005

All payments must be made by electronic transfer quoting the above invoice number to AIB A/c No. xxxxx xxxxx sort code xx-xx-xx. Payments of up to €1,270 can be made by cheque made payable to ESB Networks at the above address quoting the above invoice number.

Contract Account No	Invoice No	Total
116000000003	900000702	
	2	1,618.53



Points to Note: No amount re-invoiced for accepted designated dispute raised in Scenario two on invoice item number 3200000498. The reversal of the original amount charged in included in the credit note displayed in T4.2.



Supplier No:
SXX

Invoice No:
900000703

Power Supply
1 Any Street
Any Town
Ireland

Payment Enquiries to:
Billing & Income Office
ESB Networks Sarsfield Rd Wilton
Cork T12 E367
Telephone No:
1850200810

Document Type: Credit Note

Date: 03/05/2005

Description	Amount
Credits for accepted designated disputes	170.00 CR
VAT @ 13.5%	22.95 CR
Total EUR	192.95 CR

All payments must be made by electronic transfer quoting the above invoice number to AIB A/c No. xxxxx xxxxx sort code xx-xx-xx. Payments of up to €1,270 can be made by cheque made payable to ESB Networks at the above address quoting the above invoice number.

Contract Account No	Invoice No	Total
116000000003	900000703	192.95 CR



Points to Note: Adjustment credit relates to reversal of original amount of accepted designated dispute raised by the Supplier in Scenario two on invoice item number 3200000498.

Exhibit ID: T4.3a

Invoice No.			Detailed Transaction Charges				
From Date			01.04.2005				
To Date			29.04.2005				
Sender ID			DSO				
Recipient ID			SXX				
Time/Date			03/05/2005				
Invoice Item No	Market Participant Business Reference	Transaction Description	MPRN	Net Amount	VAT Amount	Gross Amount	
3200000604	A5559444		10000055555	185.00	24.98	209.98	
3200000605	A5559446	INSTALL NSH MT & T/S	10000066397	158.00	21.33	179.33	
3200000609	A5559444	INST SIGNALS EXT MFM	10000000007	170.00	22.95	192.95	
3200000615	A5556666	EXCH MD FOR MD+SGNLS	10065987546	649.00	87.62	736.62	
3200000622	A5556984	REMOVE NSH MT & T/S	10009005621	171.00	23.09	194.09	
3200000625	A5556344	RE-ENERGISE	10000732145	93.00	12.56	105.56	
Total Records			6				
Control Total			1618.53				
End of File							

Exhibit ID: T4.3b

Invoice No.			Detailed Transaction Charges				
From Date			01.04.2005				
To Date			29.04.2005				
Sender ID			DSO				
Recipient ID			SXX				
Time/Date			03/05/2005				
Invoice Item No	Market Participant Business Reference	Transaction Description	MPRN	Net Amount	VAT Amount	Gross Amount	
2200000020	A5556662	INST SIGNALS EXT MFM	10000639584	-170.00	-22.95	-192.95	
Total Records			1				
Control Total			192.95				
End of File							

Points to Note: Item in red is reversal of accepted designated dispute raised by the Supplier in Scenario two.

Transaction Statement of Account
Date: 05/04/05 to 03/05/05

Supplier No: SXX
 Contract Account No: 116000000003
 Address: 1 Any Street, Any Town

Date	Ref No.	Description	Amount	Balance
			€	€
05/04/05		Opening balance		913.69
18/04/05		Payment	-421.10	492.59
03/05/05	900000703	Adjustment Credit Charges	-192.95	299.64
03/05/05	900000702	Transaction Charges for Current Period	1,618.53	1,918.17
03/05/05		Closing balance		1,918.17
		Designated Disputes in Progress		-120.31
		Amount Due		1,797.86

Points to Note: Designated dispute on invoice number 900000675 is still in progress and so is deducted from the closing balance to arrive at the amount due for payment.



Transaction Charges - Dispute Summary

Date: 05/04/05 to 03/05/05

Supplier No: SXX
 Contract Account No: 116000000003
 Address: 1 Any Street, Any Town

Designated Disputes

Invoice Date	Invoice No.	Disputes In Progress	Disputes Accepted	Disputes Denied
		€	€	€
02/03/2005	900000623		192.95	179.33
04/04/2005	900000675	120.31		
Total		120.31	192.95	179.33

Resolved Amounts Now Due	192.95	179.33
---------------------------------	---------------	---------------

Non Designated Disputes

Invoice Date	Invoice No.	Disputes In Progress	Disputes Accepted	Disputes Denied
		€	€	€
Total		0.00	0.00	0.00

Points to Note: Disputes were raised on two invoices. The disputes on invoice number 900000623 have been resolved, one accepted and the other denied. The dispute on invoice number 900000675 is still in progress at this point in time.

Exhibit ID: T4.6

**Transaction Charges - Dispute
Detail**

Date: 05/04/05 to 03/05/05

Supplier No: SXX
Contract Account No: 116000000003
Address: 1 Any Street, Any Town

Invoice No	Invoice Item No	MPRN	Market Participant Business Reference	Amount	Dispute Type	Reason Code	Dispute Status	Raised On	Resolved On
900000623	3200000498	10000639584	A5556662	192.95	DD	SNR	Accepted	07/03/2005	04/04/2005
900000623	3200000523	10000003639	A5556682	179.33	DD	SNR	Denied	08/03/2005	05/04/2005
900000675	3200000556	10012336669	A5559334	120.31	DD	SNR	In Progress	15/04/2005	
Total Records		3							
End									

Points to Note: The report now shows that the two disputes on invoice number 900000623 have been resolved – one accepted, one denied. The one dispute on invoice number 900000675 is still in progress at this point in time.

Exhibit ID: T4.7

Remittance Advice						
<u>Current Inv (C)</u> <u>/Resolved Desig.</u>	<u>Invoice No.</u>	<u>MPRN</u>	<u>Invoice Item No</u>	<u>Invoice Amount</u>	<u>Control Message Amount</u>	<u>Payment Amount</u>
<u>Dispute (R)</u>						
C	900000702	See Detailed Transaction Charges		1,618.53		1,618.53
R	900000623	See Dispute Detail File		179.33		179.33
Key:					EFT Amount	1,797.86
Input by Supplier - All Other cells are locked						

Points to Note: This is the remittance advice as sent to the Supplier. Amount due for payment is in respect of two items – (1) the current invoice and (2) the denied designated dispute.

The remittance advice as completed by the Supplier and returned to ESB Networks is displayed in T4.9.

Exhibit ID: T4.8

Header Level	Message Header	
Information – Level 1	Message Type	507C
	Version number	01.00.00
	Time Stamp	2005-05-16-14-42-20
	Senders ID	SXX
	Recipient ID	DSO
	Transaction Reference number	A2040001
MPRN Level Information – Level 2	Meter Point Reference Number	
	Market Participant Business Reference	
	Invoice No	900000702
	Invoice Item No	
	Dispute Reason	
	Amount Disputed Total	0
	Number of dispute records	0

Points to Note: 507C message - no designated disputes raised by the Supplier on the current invoice during this Scenario i.e. no 507 messages raised by the Supplier.

Exhibit ID: T4.9

Remittance Advice

<u>Current Inv (C) /Resolved Desig. Dispute (R)</u>	<u>Invoice No.</u>	<u>MPRN</u>	<u>Invoice Item No</u>	<u>Invoice Amount</u>	<u>Control Message Amount</u>	<u>Payment Amount</u>
C	900000702	See Detailed Transaction Charges		1,618.53	0.00	1,618.53
R	900000623	See Dispute Detail File		179.33		179.33
Key:					EFT Value	1,797.86

Input by Supplier - All Other cells are
locked

Points to Note: This is the remittance advice as completed by the Supplier. The Supplier inserts the 507C message amount into the Control Message Amount cell, which automatically calculates the Payment Amount and EFT Amount.

8 PSO Invoicing, Payments and Disputes - Documentation

8.1 Overview

This section illustrates the documentation that a Supplier will receive from ESB Networks over the course of a number of a PSO invoicing scenarios. The purpose of the scenarios is to illustrate how the payment process will work in possible scenarios.

Three scenarios of PSO invoicing will be demonstrated. The events occurring in each scenario will be referenced to the relevant steps in MPD 34 and to sample formats of the relevant documentation. The three scenarios are as follows:

Scenario	Invoice Date	Timeframe	Scenario Feature
One	2 February	2 Feb – 1 Mar	Standard
Two	2 March	2 Mar – 3 Apr	Adjustment to previous month invoice
Three	2 March	2 Mar – 3 Apr	PSO Payment

As indicated in the above table, a scenario will cover the period of time from the issue of the current invoice to the issue of next invoice.

Note:

- **Dates, document numbers (i.e. invoice numbers etc) and monetary amounts are for illustrative purposes only.**
- **Volumes and types of consumption data are simplified to aid comprehension and are not intended to be representative of a typical Supplier.**
- **Template designs are subject to change.**

8.2 Scenario One

The sequence of events in Scenario One is as follows:

Role	Description	Exhibit ID	MPD Step
N	PSO Levy for January is calculated and an invoice is created. This along with backing documentation is issued to Supplier on 2 nd February via SFTS / EE.	P1.1,P1.2	18
S	Supplier receives documentation and processes information.		19
S	Supplier makes full payment for amount due via EFT on due date, which in the example has been calculated as 16 th February.		22
N	Finally, ESB Networks processes the payment against the Supplier account.		21, 23, 26

N = ESB Networks; S = Supplier

Scenario. Key points or features are noted below each exhibit.

8.3 Scenario Two

The sequence of events in Scenario Two is as follows:

Role	Description	Exhibit ID	MPD Step
N	PSO Levy for February is calculated and an invoice is created. ESB Networks reviews the PSO Levy for January and finds that an amendment is required. An adjustment invoice is created to reflect this.		
N	Both invoices and backing documentation are issued to Supplier on 2 nd March via SFTS / EE	P2.1 to P2.4	18
S	Supplier receives documentation and processes information.		19
S	Supplier makes full payment for amount due via EFT on due date, which in the example has been calculated as 16 th March.		22
N	Finally, ESB Networks processes the payment against the Supplier account.		21, 23, 26

N = ESB Networks; S = Supplier

Scenario Key points or features are noted below each exhibit.

8.4 Scenario Three

In this scenario the CRU has determined that a PSO Payment will apply and therefore credit is due to the supplier in relation to previous PSO periods.

The sequence of events in Scenario Three is as follows:

Role	Description	Exhibit ID	MPD Step
N	PSO Payment for October is calculated and a credit note is created. This along with backing documentation is issued to Supplier via SFTS / EE.	P3.1,	18
S	Supplier receives documentation and processes information.		19
N	ESBN makes payment for amount due via EFT.		32

N = ESB Networks; S = Supplier

Key points or features are noted below each exhibit.

8.5 PSO Exhibits

Exhibit ID	Exhibit Name	Page
Scenario One		
P1.1	PSO Invoice	143
P1.2	Detailed Backing Documentation	120
Scenario Two		
P2.1	PSO Invoice	121
P2.2	Backing Documentation	122
P2.3	PSO Adjustment Invoice	123
P2.4	Adjustment Detailed Backing Documentation	124
Scenario Three		
P3.1	PSO Credit Note	125
	Backing documentation*	

*The Backing Documentation is as set out in P1.2 and P2.2



Supplier No:
SY Y

Invoice No:
2100000005

Power Utilities
1234 Beach Road
Portundrum
Ireland

Payment Enquiries to:
Billing & Income Office
ESB Networks Sarsfield Rd Wilton
Cork T12 E367
Telephone No:
1850200810

Document Type: Invoice

Date: 02/02/2005

Qty	Description	Amount
78	PSO1 No. of Domestic Accounts Jan 05	117.78
1,925	PSO2 No. of Small Accounts Jan 05	8,816.50
325,856	PSO3 MIC of Large Accounts Jan 05	270,460.48
		279,394.76
	Less Supplier Administration Charge	7,000.00
		272,394.76
	VAT @ 13.5%	36,773.29
Total EUR		309,168.05

Payment terms: 10 Business Days

Due Date: 16/02/2005

All payments must be made by electronic transfer quoting the above invoice number to AIB A/c No. xxxxxx xxxxx sort code xx-xx-xx. Payments of up to €1,270 can be made by cheque made payable to ESB Networks at the above address quoting the above invoice number.

Contract Account No	Invoice No	Total
116000000002	2100000005	309,168.05

Points to Note: Contract account number indicates the account type, in the example, the Supplier PSO Account.

Extract from Backing Documentation		
Sender ID		DSO
Recipient ID		SYT
Time/Date		01/02/2005
Month End Date		31/01/2005
MPRN	PSO Classification	MIC
100000967236	PS01	
100000967235	PS02	
100000967234	PSO3	1455
100000967233	PSO2	
100000967232	PSO2	
100000967231	PSO3	1825
100000967230	PSO2	
100000967229	PSO2	
100000967228	PSO3	1638
100000967227	PSO3	1450
100000632236	PS01	
"	"	"
"	"	"
Total Records	1008	
End of File		

Points to Note: The above extract from the flat file for illustration purposes only as the file as sent by ESB Networks will not contain any row headings etc. Guidelines for using this file are contained in Section 9 of this document.



Supplier No:
SYY

Invoice No:
2100000024

Power Utilities
1234 Beach Road
Portundrum
Ireland

Payment Enquiries to:
Billing & Income Office
ESB Networks Sarsfield Rd Wilton
Cork T12 E367
Telephone No:
1850200810

Document Type: Invoice

Date: 02/03/2005

Qty	Description	Amount
82	PSO1 No. of Domestic Accounts Feb 05	123.82
1,935	PSO2 No. of Small Accounts Feb 05	8,862.30
325,856	PSO3 MIC of Large Accounts Feb 05	270,460.48
		279,446.60
	Less Supplier Administration Charge	7,000.00
		272,446.60
	VAT @ 13.5%	36,780.29
Total EUR		309,226.89

Payment terms: 10 Business Days

Due Date: 16/03/2005

All payments must be made by electronic transfer quoting the above invoice number to AIB A/c No. xxxxx xxxxx sort code xx-xx-xx. Payments of up to €1,270 can be made by cheque made payable to ESB Networks at the above address quoting the above invoice number.

Contract Account No	Invoice No	Total
1160000000002	21000000024	309,226.89

Extract from Backing Documentation

Sender ID	DSO
Recipient ID	SY
Time/Date	01/03/2005
Month End Date	28/02/2005

MPRN	PSO Classification	MIC
100000967236	PS01	
100000967235	PS02	
100000967234	PS03	1455
100000967233	PS02	
100000967231	PS03	1825
100000967230	PS02	
100000967229	PS02	
100000967228	PS03	1638
100000967227	PS03	1450
100000632236	PS01	
"	"	"
"	"	"
"	"	"
Total Records	1011	
End of File		



Supplier No:
SYY

Invoice No:
2100000025

Power Utilities
1234 Beach Road
Portundrum
Ireland

Payment Enquiries to:
Billing & Income Office
ESB Networks Sarsfield Rd Wilton
Cork T12 E367
Telephone No:
1850200810

Document Type: Invoice

Date: 02/03/2005

Qty	Description	Amount
-1	PSO1 No. of Domestic Accounts – Adjustments for Jan 05	-1.51
2	PSO2 No. of Small Accounts – Adjustments for Jan 05	9.16
		7.65
	VAT @ 13.5%	1.03
Total EUR		8.68

Payment terms: 10 Business Days

Due Date: 16/03/2005

All payments must be made by electronic transfer quoting the above invoice number to AIB A/c No. xxxxx xxxxx sort code xx-xx-xx. Payments of up to €1,270 can be made by cheque made payable to ESB Networks at the above address quoting the above invoice number.

Contract Account No	Invoice No	Total
116000000002	21000000025	8.68



Extract from Backing Documentation

Sender ID DSO
Recipient ID SYY
Time/Date 01/03/2005
Month End Date 31/01/2005

Adjustment Type	MPRN	PSO Classification	MIC
D	100000967232	PS02	
A	100000967215	PS03	1300
D	100000632236	PS01	
Total Records	3		
End of File			

Exhibit ID: P3.1

Please quote this number when contacting ESB Networks DAC

ESB Networks DAC

Supplier Number

SXX



Invoice Number

170000XXXX

Vat No. IE 9660798 N

Date: 15.03.2023

Payments / Enquiries to:

SUPPLIER NAME
SUPPLIER ADDRESS
SUPPLIER ADDRESS
SUPPLIER ADDRESS

Billing & Income Office,
ESB Networks,
Sarsfield Road,
Wilton,
Cork.

PSO Invoice	DOCUMENT TYPE	
All payments must be made by electronic funds transfer, quoting the above invoice number, to AIB a/c 81900244, sorting code 932086; Payments of up to €1270 can be made by cheque, made payable to ESB Networks DAC at the above address, quoting the above invoice number		
Qty	Description	Value
-10,000	PSO1 No. of Domestic Accounts	20,000.00 CR
-5,000	PSO2 No. of SME Accounts	25,000.00 CR
-2,500	PSO3 MIC of Industrial Accounts	2,500.00 CR
1	PSO Administration Charge	50.00 CR
	PSO CREDIT NOTE FEBRUARY 2023	
	Sub Total	47,550.00 CR
	VAT@ 9.0%	4,279.50 CR
THIS IS A CREDIT NOTE		
		<div style="border: 1px solid #ccc; padding: 5px; display: inline-block;"> EURO TOTAL € 51,829.50 CR </div>
ESB Networks DAC has an approved Complaints Handling Procedure that can be found on our website www.esb.ie/networks		

E.&O.E.

Please retain this counterfoil for your records

Contract Account No

11610000XXXX

Invoice Number

170000XXXX

ESB Code: 9806666.2

€ 51,829.50 CR



9 DUoS/Transaction/PSO Flat File Formats

9.1 Introduction

Purpose of the File Format Document

This document provides information to assist Suppliers in the interpretation of files provided as detail for

- Distribution Use of System (DUOS) Charges
- Transactional Charges
- PSO Rates
- DUoS and Transaction Disputes

The document includes technical information on the data definition of the flat files.

Market messages 507 and 507c are not detailed here. These market messages are documented in “Market Messages Implementation Guide - DUoS and Transaction Payments”

Technical Overview

Flat file information will be provided to Market Participants via SFTS / EE as part of a package of information delivered on a twice monthly basis for DUoS and once a month for Transaction and PSO.

9.2 File Data Formats

9.2.1 MPRN Level Invoice Item Detail – Flat File

The MPRN Level Invoice Item Detail file is sent by ESB Networks to Market Registered Suppliers to provide detailed information on the DUoS Invoice/Credit Note.

The file will be provided to the Supplier as part of a package of information related to a DUOS Invoice and Credit Note. The other documents will include:

- DUoS Group Summary
- Account Statement
- Dispute Summary
- Dispute Detail
- Remittance Advice

File Data Hierarchy Diagram

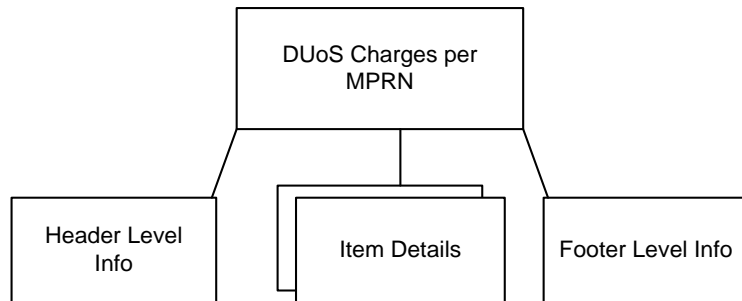

File Naming Standard

The file naming standard will be:

DUOS_<Invoice Number>_<SenderID>_<RecipientID>_<TimeStamp-Date&Time>.csv

Where TimeStamp is in the format: YYYYMMDDHHMMSS

e.g. DUOS_90000000012_DSO_SXX_20050101105500.csv

The invoice number will be the same as that included on the Supplier's printed Invoice, Credit Note and the DUoS Group Summary.

File Structure

This section describes the structure of the DUoS flat file. The purpose of the file segments and data items are explained and any rules for composition outlined.

Segment and Field Level Identifier			Rpt	Optionality	Field Size	Description / Purpose and composition instructions
1 Message Header			1	Mandatory		This is the Header information provided for each flat file record. This header segment is unique to the flat file.
2	FLD	Segment ID	1	Mandatory	NUM(1)	This is an identifier to categorise the level in the file 1 = Header Record (1 record only) 2 = Item Detail Record (1..n records) 3 = Footer Record (1 record only)
2	FLD	Invoice Number	1	Mandatory	AN(12)	This is a unique number that references the Invoice/Credit Note information being provided.
2	FLD	Sender ID	1	Mandatory	AN(3)	This is the Unique identifier of the Market Participant Sending the message. For ESB Networks this is DSO.
2	FLD	Recipient ID	1	Mandatory	AN(3)	This is the Unique identifier of the Market Participant receiving the message. This code will correspond with the Supplier ID for the Supplier Registered on the MPRN's.
2	FLD	Time Stamp	1	Mandatory	AN(14)	This is a time and date stamp indicating the time and date that the file was created. This is defined as: • YYYYMMDDHHMMSS
1 Item Details			1..N			This contains information relating to each item in the invoice.
2	FLD	Segment ID	1	Mandatory	NUM(1)	This is an identifier to categorise the level in the file 1 = Header Record (1 record only) 2 = Item Detail Record (1..n records) 3 = Footer Record (1 record only)
2	FLD	Invoice Number	1	Mandatory	AN(12)	This is a ID of the Invoice/Credit Note that the item relates to.
2	FLD	Invoice Item Number	1	Mandatory	NUM(18)	This is a unique reference to an invoice item in a file. This number can be used to reference which item(s) are being disputed in a 507 message.
2	FLD	MPRN	1	Mandatory	AN(11)	The unique identifying reference number for the Meter Point. All elements of MPRN will be provided.

2	FLD	Adjustment Reference	1	Optional	NUM(18)	Only shown where the entry relates to a reversal of a previous invoice. The adjustment reference is the invoice item number of the original entry.
2	FLD	Invoice Type	1	Mandatory	AN(2)	Code used to identify the type of invoice item Valid codes for the invoice type field are: 1S New Charge - Sequential Bill 2S Adjustment Credit - Reversal of Sequential bill 2C Adjustment Credit - Non-sequential bill credit 2D Adjustment Credit - Reversal of non-sequential bill charge 3S Adjustment Debit - Re-bill for sequential bill 3C Adjustment Debit - Reversal of non-sequential bill credit 3D Adjustment Debit - Non-sequential bill charge
2	FLD	DUOS Group	1	Mandatory	AN(4)	DUOS Group is a code which denotes to the use of system tariff applying to the MPRN provided in the item.
2	FLD	Billing Date From	1	Mandatory	AN(8)	The date from which the billing period for the item became effective. In format: • YYYYMMDD
2	FLD	Billing Date To	1	Mandatory	AN(8)	The date to which the billing period for the item was effective. In format: • YYYYMMDD
2	FLD	Day kWh Consumption	1	Optional	NUM(15,3)	This is the Day Rate Energy consumption recorded in kWh for the billing period.
2	FLD	Day Energy Charge	1	Optional	NUM(13,2)	This is the Energy charge associated to day consumption if applicable, for the billing period.
2	FLD	Night kWh Consumption	1	Optional	NUM(15,2)	This is the Night Rate Energy consumption recorded in kWh for the billing period.
2	FLD	Night Energy Charge	1	Optional	NUM(13,2)	Energy charge associated to night consumption, for the billing period.
2	FLD	24 Hr kWh Consumption	1	Optional	NUM(15,2)	The 24 Hr energy consumption recorded in kWh for the billing period.
2	FLD	24 Hr Energy Charge	1	Optional	NUM(13,2)	Energy charge associated to 24 Hr consumption, for the billing period.

2	FLD	Standing Charge	1	Optional	NUM(13,2)	This is a time based charge calculated per customer, for the billing period..
2	FLD	Capacity Charge	1	Optional	NUM(13,2)	This is a standing charge per kVA per month for agreed MIC, for the billing period..
2	FLD	Maximum Import Capacity	1	Optional	NUM(16,7)	Maximum Import Capacity is the capacity in kVA agreed in the connection agreement and permitted to be imported at a meter point.
2	FLD	Max kVA	1	Optional	NUM(15,3)	This is the recorded max kVA for the MPRN during the billing period.
2	FLD	MIC Surcharge	1	Optional	NUM(13,2)	This is a Surcharge applied when a customer exceeds an agreed MIC, for the billing period.
2	FLD	Reactive Energy (kVarh)	1	Optional	NUM(15,2)	This is recorded reactive energy in kVarh, for the billing period.
2	FLD	Power Factor Surcharge	1	Optional	NUM(13,2)	This is a surcharge applied where kVarh exceeds one third of KWH where appropriate.
2	FLD	Day Off Peak kWh	1	Optional	NUM(15,2)	This is the Day Off Peak energy consumption recorded in kWh from 8.00hrs to 23.00hrs (excluding peak) for the billing period,
2	FLD	Day Off Peak Charge	1	Optional	NUM(15,2)	This is the Energy charge associated to Day Off Peak consumption if applicable, for the billing period
2	FLD	Night Off Peak kWh	1	Optional	NUM(15,2)	This is the Night Rate Energy consumption recorded in kWh from 23.00hrs to 8.00hrs for the billing period.
2	FLD	Night Off Peak Charge	1	Optional	NUM(15,2)	Energy charge associated to Night Off Peak consumption, for the billing period.
2	FLD	Peak kWh	1	Optional	NUM(13,2)	This is the Peak energy consumption recorded in kWh from 17.00hrs to 19.00hrs for the billing period
2	FLD	Peak Charge	1	Optional	NUM(13,2)	Energy charge associated to Peak consumption for the billing period.
2	FLD	QH Day Off Peak kWh	1	Optional	NUM(15,2)	This is the QH Day Off Peak energy consumption recorded in kWh from 8.00hrs to 23.00hrs (excluding peak) for the billing period,
2	FLD	QH Day Off Peak Charge	1	Optional	NUM(13,2)	This is the Energy charge associated to QH Day Off Peak consumption if applicable, for the billing period

2	FLD	QH Night Off Peak kWh	1	Optional	NUM(15,2)	This is the QH Night Rate Energy consumption recorded in kWh from 23.00hrs to 8.00hrs for the billing period.
2	FLD	QH Day Off Peak Charge	1	Optional	NUM(13,2)	Energy charge associated to QH Night Off Peak consumption for the billing period.
2	FLD	QH Peak kWh	1	Optional	NUM(13,2)	This is the QH Peak energy consumption recorded in kWh from 17.00hrs to 19.00hrs for the billing period
2	FLD	QH Peak Charge	1	Optional	NUM(13,2)	Energy charge associated to QH Peak consumption for the billing period.
2	FLD	Net Amount	1	Mandatory	NUM(13,2)	Total Net Amount for the Invoice Item specified. Does not include VAT.
2	FLD	Gross Amount	1	Mandatory	NUM(13,2)	Total Gross Amount for the Invoice Item specified i.e. the Net Amount and a distribution of the associated VAT. Note: because VAT is calculated at the aggregate invoice/credit note level, the apportioning of VAT at the MPRN level to determine the Gross values may have minor rounding differences. This is the gross amount to be withheld in case of a designated dispute.
1 Footer			1			This item denotes the end of the particular flat file provided and control information on the number of records and total amounts.
2	FLD	Segment ID	1	Mandatory	NUM(1)	This is an identifier to categorise the level in the file 1 = Header Record (1 record only) 2 = Item Detail Record (1..n records) 3 = Footer Record (1 record only)
2	FLD	Total Records	1	Mandatory	NUM(9)	The total number of invoice items in the file, excluding the header and footer line. This should equal the total number of records shown in the Summary by DUoS Group Report
2	FLD	Control Total	1	Mandatory	NUM(13,2)	Summation of all <u>Net</u> Amounts shown in the detailed file. This should equal the total amount shown in the DUoS Group Summary.

Additional File Details

- The file data will be comma delimited.
- The field size shown is the maximum permissible; if the data is smaller in size than the field maximum then no placeholders will be used. e.g. the invoice number is supplied as 9000001 not 0000090000001.
- Placeholders after the decimal point will always be provided e.g. 12.000 not 12
- Field sizes shown do not include allowance for decimal points, these will add one further character to each field if used. e.g. NUM(3,2) = 123.45
- Negative signs will be shown after the value e.g. 130.000- and are not included in the maximum size values above.
- If no values exist for a given field then the value will be blank i.e.. ...,.... not ...,0.000,...

9.2.2 Detailed Transaction Charges – Flat File

The detailed transaction charges file is sent by ESB Networks to Market Registered Suppliers to provide detailed information on the Transaction Invoice/ Credit Note.

The file will be provided to the Supplier as part of a package of information related to the Transaction Invoice and Credit Note. The other documents will include:

- Account Statement
- Dispute Summary
- Dispute Detail
- Remittance Advice

File Data Hierarchy Diagram

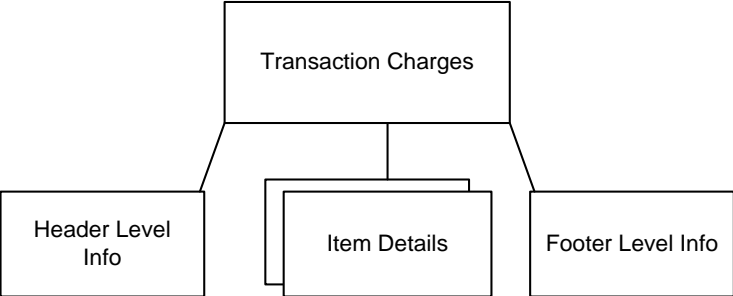

File Naming Standard

The file naming standard will be:

TRANSACTION_<Invoice Number>_DSO_< Recipient ID >_<TimeStamp-Date&Time>.csv

Where TimeStamp is in the format: YYYYMMDDHHMMSS

e.g. TRANSACTION_ 90000057 _DSO_ SXX_20050101105500.csv

The invoice number will be the same as that included on the Supplier's printed transaction invoice.

File Structure

This section describes the structure of the transaction flat file. The purpose of the file segments and data items are explained and any rules for composition outlined.

Segment and Field Level Identifier			Rpt	Optionality	Field Size	Description / Purpose and composition instructions
1 Message Header			1	Mandatory		This is the Header information provided for each flat file record. This header segment is unique to the flat file.
2	FLD	Segment ID	1	Mandatory	NUM(1)	This is an identifier to categorise the level in the file 1 = Header Record (1 record only) 2 = Item Detail Record (1..n records) 3 = Footer Record (1 record only)
2	FLD	Invoice Number	1	Mandatory	AN(12)	This is a unique number that references the Invoice Number or Credit Note.
2	FLD	From date	1	Mandatory	DATE(10)	From date is the earliest date of an invoice item.
2	FLD	To date		Mandatory	DATE(10)	To date is latest date of an invoice item.
2	FLD	Sender ID	1	Mandatory	AN(3)	This is the Unique identifier of the Market Participant Sending the message. For ESB Networks this is DSO.
2	FLD	Recipient ID	1	Mandatory	AN(3)	This is the Unique identifier of the Market Participant receiving the message. This code will correspond with the Supplier ID for the Supplier Registered on the MPRN's.
2	FLD	Time Stamp	1	Mandatory	AN(14)	This is a time and date stamp indicating the time and date that the file was created. This is defined as:

						• YYYYMMDDHHMMSS
1 Item Details			1..N			This contains information relating to each item in the record.
2	FLD	Segment ID	1	Mandatory	NUM(1)	This is an identifier to categorise the level in the file 1 = Header Record (1 record only) 2 = Item Detail Record (1..n records) 3 = Footer Record (1 record only)
2	FLD	Invoice Item Number	1	Mandatory	NUM(10)	This is the unique individual invoice item number applicable to the transaction charge.
2	FLD	Market Participant Business Reference	1	Optional	Num(20)	This is the unique number that the Supplier may give as their reference for the particular transaction. Otherwise, this field will remain blank.
2	FLD	Transaction Charge Description	1	Mandatory	Char_20)	This a description of the invoice item e.g. MRSO, Revenue Protection. Where the invoice item relates to a charge for meter works, a more detailed description is given e.g. re-energise, de-energise etc.
2	FLD	MPRN	1	Mandatory	Num(11)	The unique identifying reference number for the Meter Point. All elements of MPRN will be provided.
2	FLD	<i>Net Amount</i>	1	Mandatory	Num(13,2)	The net amount of the individual transaction
2	FLD	Vat Amount	1	Mandatory	Num(13,2)	The VAT amount of the individual transaction
2	FLD	Gross Amount	1	Mandatory	Num(13,2)	The gross amount of the individual transaction. This is the amount to be withheld in case of a designated dispute.
1 Footer						This item denotes the end of the particular flat file provided and control information on the number of records and total amounts.
2	FLD	Segment ID	1	Mandatory	NUM(1)	This is an identifier to categorise the level in the file 1 = Header Record (1 record only) 2 = Item Detail Record (1..n records) 3 = Footer Record (1 record only)
2	FLD	Total Records	1	Mandatory	NUM(9)	The total number of invoice items in the file, excluding the header and footer line.
2	FLD	Control Total	1	Mandatory	NUM(13,2)	Summation of all <u>gross</u> amounts shown in the detailed file. This should equal the sum of gross amounts shown in the Invoice and Credit Note.

Example of File Data

1,900000057,20040301,20040331,DSO,SXX,20050212212053
2,3200000205,789532565,10000000155,200.00,27.00,227.00
2,3200000204,789532568,10000000154,100.00,13.50,113.50
2,3200000203,789532569,10000000150,158.00,21.33,179.33
2,3200000202,789532570,10000000151,158.00,21.33,179.33
3,4,699.16

Additional File Details

- The file data will be comma delimited.
- The field size shown is the maximum permissible; if the data is smaller in size than the field maximum then no placeholders will be used. e.g. the invoice number is supplied as 9000001 not 0000090000001.
- Placeholders after the decimal point will always be provided e.g. 12.000 not 12
- Field sizes shown do not include allowance for decimal points, these will add one further character to each field if used. e.g. NUM(3,2) = 123.45
- Negative signs will be shown after the value e.g. 130.000- and are not included in the maximum size values above.

9.2.3 PSO Invoice Detailed Backing Documentation – Flat File

This file will be provided by ESB Networks to each Market Registered Supplier as backing documentation for PSO invoices or PSO Credit Notes where applicable. One file will be produced per supplier per month. The file will contain detailed information in respect of every MPRN, registered to the Market Registered Supplier, that attracted a PSO Levy or PSO Payment.

File Data Hierarchy Diagram

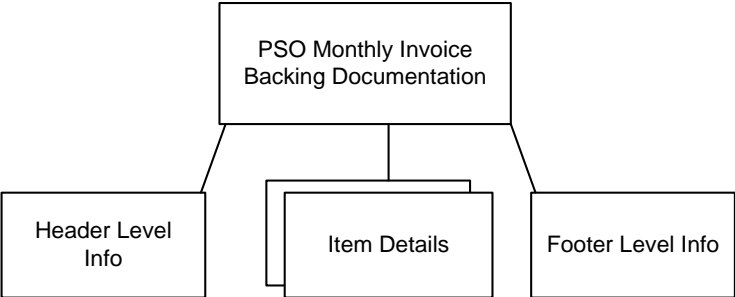

File Naming Standard

The file naming standard will be:
 PSO_Monthly_<Month End Date>_<SenderID>_<RecipientID>_<TimeStamp-Date&Time>.csv
 Month End Date is in the format: YYYYMMDD
 TimeStamp is in the format: YYYYMMDDHHMMSS

e.g. PSO_Monthly_20050101_DSO_SXX_20050101105500.csv

File Structure

This section describes the structure of the PSO flat file. The purpose of the file segments and data items are explained and any rules for composition outlined.

Segment and Field Level Identifier	Rpt	Optionality	Field Size	Description / Purpose and composition instructions
------------------------------------	-----	-------------	------------	--

1 Message Header			1	Mandatory		This is the Header information provided for each flat file record. This header segment is unique to the flat file.
2	FLD	Segment ID	1	Mandatory	NUM(1)	This is an identifier to categorise the level in the file 1 = Header Record (1 record only) 2 = Item Detail Record (1..n records) 3 = Footer Record (1 record only)
2	FLD	Sender ID	1	Mandatory	AN(3)	This is the Unique identifier of the Market Participant Sending the message. For ESB Networks this is DSO
2	FLD	Recipient ID	1	Mandatory	AN(3)	This is the Unique identifier of the Market Participant receiving the message. This code will correspond with the Supplier ID for the Supplier Registered on the MPRN's.
2	FLD	Time Stamp	1	Mandatory	AN(14)	This is a time and date stamp indicating the time and date that the file was created. This is in the format YYYYMMDDHHMMSS
2	FLD	Month End Date	1	Mandatory	AN(8)	The month end date of the associated PSO invoice in the format YYYYMMDD
1 Item Details			1..N			A detail record will be provided containing information relating to each MPRN that attracted a PSO charge in the month end period contained in the Header record.
2	FLD	Segment ID	1	Mandatory	NUM(1)	This is an identifier to categorise the level in the file 1 = Header Record (1 record only) 2 = Item Detail Record (1..n records) 3 = Footer Record (1 record only)
2	FLD	MPRN	1	Mandatory	AN(11)	The unique identifying reference number for the Meter Point. All elements of MPRN will be provided.
2	FLD	PSO Classification	1	Mandatory	AN(4)	This identifies the PSO Classification relevant to the MPRN and is in the format PSO _n where n can equal 1, 2 or 3.
2	FLD	MIC	1	Optional	NUM(16,7)	Maximum Import Capacity is the capacity in kVA agreed in the connection agreement and permitted to be imported at a meter point.
1 Footer			1			This item denotes the end of the particular flat file provided and control information on the number of records.
2	FLD	Segment ID	1	Mandatory	NUM(1)	This is an identifier to categorise the level in the file 1 = Header Record (1 record only)

						2 = Item Detail Record (1..n records) 3 = Footer Record (1 record only)
2	FLD	Total Records	1	Mandatory	NUM(9)	The total number of detail records in the file, excluding the header and footer line.

Additional File Details

- The file data will be comma delimited.
- The field size shown is the maximum permissible; if the data is smaller in size than the field maximum then no placeholders will be used. e.g. the invoice number is supplied as 9000001 not 0000090000001.
- Placeholders after the decimal point will always be provided e.g. 12.000 not 12
- Field sizes shown do not include allowance for decimal points, these will add one further character to each field if used. e.g. NUM(3,2) = 123.45
- Negative signs will be shown after the value e.g. 130.000- and are not included in the maximum size values above.
- If no values exist for a given field then the value will be blank i.e.. ...,... not ...,0.000,...

9.2.4 PSO Adjustment Invoice Detailed Backing Documentation - Flat File

This file will be provided by ESB Networks to each Market Registered Supplier as backing documentation for PSO Adjustment Invoices. One file will be produced per supplier per month end date for which there are adjustments. Each file will contain detailed information in respect of every MPRN, registered to the Market Registered Supplier that attracted a PSO adjustment.

File Data Hierarchy Diagram

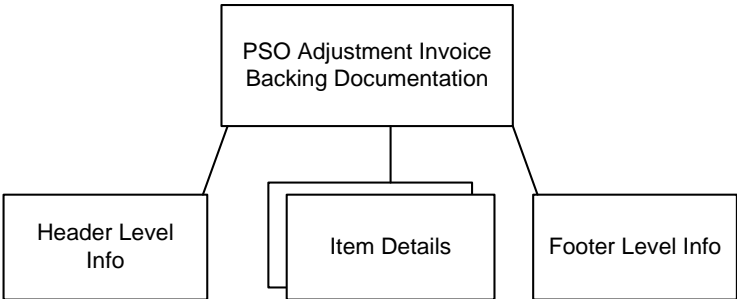

File Naming Standard

The file naming standard will be:
PSO_Adjustment_<Month End Date>_<SenderID>_<RecipientID>_<TimeStamp-Date&Time>.csv
Month End Date is in the format: YYYYMMDD
TimeStamp is in the format: YYYYMMDDHHMMSS

e.g. PSO_Adjustment_20050101_DSO_SXX_20050101105500.csv

File Structure

This section describes the structure of the PSO flat file. The purpose of the file segments and data items are explained and any rules for composition outlined.

Segment and Field Level Identifier			Rpt	Optionality	Field Size	Description / Purpose and composition instructions
1 Message Header			1	Mandatory		This is the Header information provided for each flat file record. This header segment is unique to the flat file.
2	FLD	Segment ID	1	Mandatory	NUM(1)	This is an identifier to categorise the level in the file 1 = Header Record (1 record only) 2 = Item Detail Record (1..n records) 3 = Footer Record (1 record only)
2	FLD	Sender ID	1	Mandatory	AN(3)	This is the Unique identifier of the Market Participant Sending the message. For ESB Networks this is DSO
2	FLD	Recipient ID	1	Mandatory	AN(3)	This is the Unique identifier of the Market Participant receiving the message. This code will correspond with the Supplier ID for the Supplier registered on the MPRN's.
2	FLD	Time Stamp	1	Mandatory	AN(14)	This is a time and date stamp indicating the time and date that the file was created. This is in the format YYYYMMDDHHMMSS
2	FLD	Month End Date	1	Mandatory	AN(8)	The month end date of the associated PSO invoice in the format YYYYMMDD
1 Item Details			1..N			A detail record will be provided containing information relating to each MPRN that attracted a PSO adjustment charge in the month end period contained in the Header record.
2	FLD	Segment ID	1	Mandatory	NUM(1)	This is an identifier to categorise the level in the file 1 = Header Record (1 record only) 2 = Item Detail Record (1..n records) 3 = Footer Record (1 record only)
2	FLD	Adjustment Type	1	Mandatory	A(1)	Identifies the type of adjustment – “A” = Additional “D” = Deletion
2	FLD	MPRN	1	Mandatory	AN(11)	The unique identifying reference number for the Meter Point. All elements of MPRN will be provided.
2	FLD	PSO Classification	1	Mandatory	AN(4)	This identifies the PSO Classification relevant to the MPRN and is in the format PSOn where n can equal 1, 2 or 3.
2	FLD	MIC	1	Optional	NUM(16,7)	Maximum Import Capacity is the capacity in kVA agreed in the connection agreement and permitted to be imported at a meter point.

1 Footer			1			This item denotes the end of the particular flat file provided and control information on the number of records.
2	FLD	Segment ID	1	Mandatory	NUM(1)	This is an identifier to categorise the level in the file 1 = Header Record (1 record only) 2 = Item Detail Record (1..n records) 3 = Footer Record (1 record only)
2	FLD	Total Records	1	Mandatory	NUM(9)	The total number of detail records in the file, excluding the header and footer line.

Additional File Details

- The file data will be comma delimited.
- The field size shown is the maximum permissible; if the data is smaller in size than the field maximum then no placeholders will be used. e.g. the invoice number is supplied as 9000001 not 0000090000001.
- Placeholders after the decimal point will always be provided e.g. 12.000 not 12
- Field sizes shown do not include allowance for decimal points, these will add one further character to each field if used. e.g. NUM(3,2) = 123.45
- Negative signs will be shown after the value e.g. 130.000- and are not included in the maximum size values above.
- If no values exist for a given field then the value will be blank i.e..,... not ...,0.000,...

9.2.5 Dispute Detail – Flat File

The dispute detail file will be sent by ESB Networks to each Market Registered Supplier to provide detailed information on disputes raised by the Supplier on DUoS and Transaction invoices. The file will be provided to Suppliers via SFTS / EE as part of a package of information related to DUoS or Transaction charges.

File Data Hierarchy Diagram

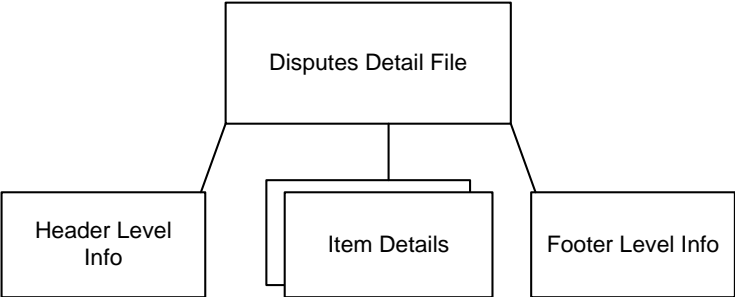

File Naming Standard

The file naming standard will be:

For DUoS disputes: DUoS_<SenderID>_<RecipientID>_<TimeStamp-Date&Time>.csv
E.g. DUoS_DSO_SXX_20050101105500.csv

For Transaction disputes: TRANSACTION_<SenderID>_<RecipientID>_<TimeStamp-Date&Time>.csv
E.g. TRANSACTION_DSO_SXX_20050101105500.csv

File Structure

This section describes the structure of the Dispute Detail flat file. The purpose of the file segments and data item are explained and any rules for composition outlined.

Segment and Field Level Identifier			Rpt	Optionality	Field Size	Description / Purpose and composition instructions
1 Message Header			1	Mandatory		This is the Header information provided for each flat file record. This header segment is unique to the flat file.
2	FLD	Segment ID	1	Mandatory	NUM(1)	This is an identifier to categorise the level in the file 1 = Header Record (1 record only) 2 = Item Detail Record (1..n records) 3 = Footer Record (1 record only)
2	FLD	Sender ID	1	Mandatory	AN(3)	This is the Unique identifier of the Market Participant Sending the message. For ESB Networks this is DSO
2	FLD	Recipient ID	1	Mandatory	AN(3)	This is the Unique identifier of the Market Participant receiving the message. This code will correspond with the Supplier ID for the Supplier Registered on the MPRN's.
2	FLD	From Date	1	Mandatory	AN(8)	From date is the date of the last account statement / dispute summary.
2	FLD	To Date	1	Mandatory	AN(8)	To date is the date of the current account statement / dispute summary.
2	FLD	Time Stamp	1	Mandatory	AN(14)	This is a time and date stamp indicating the time and date that the file was created. This is in the format YYYYMMDDHHMMSS
1 Item Details			1..N			A detail record will be provided containing information relating to each MPRN that attracted a PSO adjustment charge in the month end period contained in the Header record.
2	FLD	Segment ID	1	Mandatory	NUM(1)	This is an identifier to categorise the level in the file 1 = Header Record (1 record only) 2 = Item Detail Record (1..n records) 3 = Footer Record (1 record only)
2	FLD	Invoice Number	1	Mandatory	AN(12)	This is a unique number that references the Invoice Number.
2	FLD	Invoice Item Number	1	Mandatory	NUM(10)	This is the unique individual invoice item number applicable to the DUoS or transaction charge.

2	FLD	MPRN	1	Mandatory	AN(11)	The unique identifying reference number for the Meter Point. All elements of MPRN will be provided.
2	FLD	Market Participant Business Reference	1	Optional	Num(20)	This is the unique number that the Supplier may give as their reference for the particular transaction invoice item. Otherwise, this field will remain blank.
2	FLD	Gross Amount	1	Mandatory	Num(13,2)	The gross amount of the individual invoice item.
2	FLD	Dispute Type	1	Mandatory	AN(2)	Dispute Type indicates whether the dispute is Designated (DD) or Non-Designated (ND).
2	FLD	Dispute Reason	1	Mandatory	AN(3)	This is the reason that the invoice item number is being disputed. Refer to <i>Market Message Implementation Guide – DUoS and Transaction Payments</i> for reason codes.
2	FLD	Dispute Status	1	Mandatory	AN(10)	Dispute Status identifies whether the dispute is in progress, accepted or denied.
2	FLD	Date Raised On	1	Mandatory	AN(8)	Date Raised On identifies the date on which the dispute was notified to ESB Networks by the Supplier.
2	FLD	Date Resolved On	1	Mandatory	AN(8)	Date Resolved On identifies the date on which the dispute was resolved by ESB Networks.
1 Footer			1			This item denotes the end of the particular flat file provided and control information on the number of records.
2	FLD	Segment ID	1	Mandatory	NUM(1)	This is an identifier to categorise the level in the file 1 = Header Record (1 record only) 2 = Item Detail Record (1..n records) 3 = Footer Record (1 record only)
2	FLD	Total Records	1	Mandatory	NUM(9)	The total number of detail records in the file, excluding the header and footer line.

Examples of File Data

1,DSO,SXX,20050101,20050131,20050212212053
2, 900000058,3200000205,10000000155,789532565,227.00,Designated,SNR,INPROGRESS,20041215,
2, 900000058,3200000204,10000000154,789532568,113.50,Designated,SNR,ACCEPTED,20041225,20050105
2, 900000057,3200000203,10000000150,789532569,179.33,Non Designated,,INPROGRESS,20041210,
3,3

Additional File Details

- The file data will be comma delimited.
- The field size shown is the maximum permissible; if the data is smaller in size than the field maximum then no placeholders will be used. e.g. the invoice number is supplied as 9000001 not 0000090000001.
- Placeholders after the decimal point will always be provided e.g. 12.000 not 12
- Field sizes shown do not include allowance for decimal points, these will add one further character to each field if used. e.g. NUM(3,2) = 123.45
- Negative signs will be shown after the value e.g. 130.000- and are not included in the maximum size values above.
- If no values exist for a given field then the value will be blank i.e.. ...,... not ...,0.000,...