

Supplier Communications Resulting from DUoS Billing & Invoicing

Document Updates		
Date	Description	Version
01.06.2004	Release 1	1.0
19.10.2004	Updated to reflect DRR 0012	1.1
04.12.2015	Revised Version – Incorporates changes related to MCR 1150	1.2
16.02.2021	<p>Revised Version as part of Schema Release V13.0 (Smart)</p> <p>MCR 1157 – Smart Metering Data Processing and Data Aggregation</p> <p>Revised Version to include PSO Invoicing for Commercial Storage:</p> <p>MCR1205 – Application of the PSO to Commercial Storage</p> <p>Document title updated from: <i>MIG Document – Supplier Billing Invoicing</i> to <i>Supplier Communications Resulting from DUoS Billing & Invoicing.</i></p>	2.0
16.01.2025	5.4.1 Maximum import capacity Surcharge. CRU 2007 decision on increase in MIC surcharge not reflected in market briefing paper. Formula in Section 5.4.1 to be amended. Section 7.3 Fields 23-28 explanation have been updated.	2.1

TABLE OF CONTENTS

1. Purpose of the Document.....	5
2. Summary.....	6
3. Scheduled Billing & Invoicing Processes.....	7
3.1 Scheduled Non-Interval Data Processing to Invoicing.....	7
3.2 Scheduled HH (Interval) Data Processing to Invoicing.....	10
3.3 Scheduled QH Data Processing to Invoicing.....	12
4. Business Events in the Networks Solution.....	15
4.1 Change of Supplier (CoS).....	15
4.2 Change of Legal Entity (CoLE).....	16
4.3 Change of DUoS Group.....	17
4.4 Change of MIC.....	18
4.5 Non-Interval.....	19
4.6 Customer Own reads (CoR).....	20
4.7 Special Reads.....	22
4.8 Meter Works.....	22
4.8.1 Readings for De-energisation.....	22
4.8.2 Readings for Re-energisation.....	23
4.8.3 Readings for Meter Configuration Changes.....	23
4.9 Reversal of Non-Interval Readings.....	24
4.10 QH and HH Replacement Reads.....	25
4.11 Manual Billing.....	26
4.12 Smart Data Services.....	26
5. Key Billing Concepts and Principles.....	28
5.1 Distribution Use of System (DUoS) Tariffs.....	28
5.2 Billing Periods.....	28
5.3 Proration.....	28
5.4 Surcharges.....	29
5.4.1 Maximum Import Capacity Surcharge.....	29
5.4.2 Low Power Factor Surcharges.....	31
5.5 Tariff Price Changes.....	32
5.6 Energy Consumption Determination.....	32
5.7 Billing / Invoicing Reversals.....	34
5.8 Treatment of VAT.....	34
6. Business Scenarios & <i>MPRN Level Invoice Item Detail</i> Documentation.....	36
6.1 General.....	36
6.2 Receipt of actual meter reading with values lower than previous estimated readings.....	36
6.3 Customer Own Reading Processing.....	37
6.4 Change of Supplier Process.....	39
6.5 Change of Legal Entity (CoLE) Process.....	40
6.6 Change of DUoS Group Process.....	42
6.7 Change of MIC (on its own) Process.....	44
6.8 Delayed Processing of Meter Exchange.....	46
6.9 De-energisation.....	47
6.10 Tariff Price Changes.....	48
6.11 Meter Reading with Smart Data Services.....	50
6.12 Change from MCC01 to MCC16.....	50
7. Field Descriptions of <i>MPRN Level Invoice Item Detail</i> Documentation.....	52
7.1 General.....	52

7.2	Header Fields.....	52
7.3	Item Detail Fields	52
7.4	Footer Fields	55
8.	Appendix 1 - MPRN Level Invoice Item Detail	57

1. Purpose of the Document

The purpose of this document is to provide comprehensive information on how DUoS charges will be determined and communicated to Market Participants by ESB Networks. These communications will include market messages sent to Supplier's to communicate meter reads and the *MPRN Level Invoice Item Detail* that will support the regular supplier invoicing of DUoS energy charges.

The document will also walk through a set of business scenarios to explain the relationship between messages sent and the resulting data shown on the supporting information for the invoice.

Billing, invoicing including aggregated invoicing and communication to Market Participants in respect of Unmetered MPRNs, Auto-producers and CHP Producers are not addressed in this document. Additionally, PSO and Transaction charging are not included in this document. Application of the PSO levy for Commercial Storage Sites is addressed in WP0029 Procedure for Application of PSO for Commercial Storage Sites.

This documentation should be read in conjunction with:

- **Proposals for New DUoS Billing System** – *Approved by CER in February 2004*
- **DUoS, Transaction & PSO Payment Process** – *MOIP April 2004*
- **Distribution Use of System Agreement – Framework Agreement** – *Approved by CRU 12th November 2009*
- **Approved Schedule of Distribution Use of System Charges 2004** – *(CER 03/224 – Sept 03)*
- **Meter Configuration Code Guidance Notes** – *MOIP June 2004*
- **ESB Networks DAC Statement of Charges**, www.cru.ie
- **Comms Technically Feasible (CTF) Briefing Document**
- **WP0029 Procedure for Application of PSO for Commercial Storage Sites**

2. Summary

The objective for this document is set out in Section 1 which also includes references to relevant documentation to be considered in conjunction with this document.

Section 3 provides a description of how Networks will process scheduled meter reading data and bill the appropriate Supplier for a DUoS charge.

Section 4 describes how Networks will process non-scheduled meter reading data and bill the appropriate Supplier for a DUoS charge.

Section 5 introduces some key billing concepts and principles.

Section 6 describes a range of typical business scenarios in terms of their portrayal on this backing documentation.

Section 7 provides detailed descriptions of the information to be provided at field level in *MPRN Level Invoice Item Detail* documentation which will support the validation of DUoS charges that is included on the twice a month invoicing of suppliers.

3. Scheduled Billing & Invoicing Processes

This section will describe how Networks will process scheduled Non-Interval and QH reads at MPRN level through to DUoS billing, invoicing and aggregated invoicing to suppliers including sending of messages.

3.1 Scheduled **Non-Interval** Data Processing to Invoicing

Non-Interval metering can be installed in sites that are DUoS Group DG1, DG2, DG5, or DG6.

Figure 3.1 below describes the approach to processing Non-Interval data from a data collection tool through to sending messages and producing an invoice. Each box in the diagram is described below.

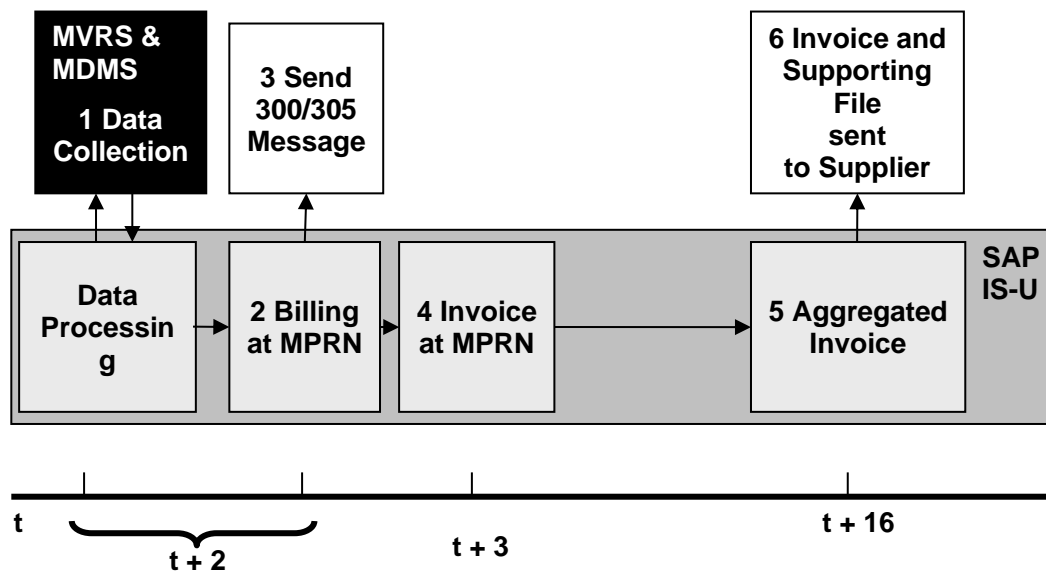

Figure 3.1: Non-Interval data processing to invoicing

1 Data Collection and Send Market Message

Figure 3.2 below depicts the meter reading / billing cycle for Non-Interval meter points.

Meter reading orders in respect of Non-Interval meter points are generated in SAP IS-U in accordance with the meter reading schedule. This generation occurs on the evening of the third working day before the scheduled read date with specific route data downloaded to the meter reading management system (MV-RS) to facilitate the collection of readings by meter readers using hand-held terminals. If the site has a SMART meter which can be remotely read, then the meter reading order is despatched to MDMS (Meter Data Management System)

Generation of Schedule Non-Interval Meter Reading / Billing Records

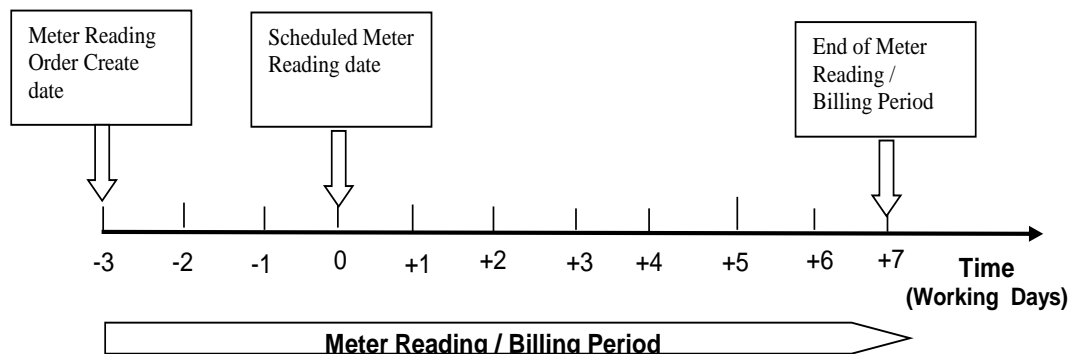

Figure 3.2: The Meter Reading Cycle.

Following reading of meters, results are uploaded via the meter reading management system to SAP IS-U. Every meter reading result is validated on the day received in accordance with determined rules. Implausible readings are investigated. Estimates are provided where no valid readings are available. Estimation will automatically occur on Day +7 for any remaining meter points which do not have an actual plausible meter reading. This estimation will be provided for the scheduled meter reading date. As a result of the meter point being billed a 300 or 305 message (estimated where no actual read obtained) is sent to the Supplier registered at that meter point.

2 Billing at MPRN

Plausible readings are made available on a daily basis to the billing process. For each meter register that accumulates consumption for billing purposes, the reading advance (i.e. the difference between the current and the previous valid reading with the relevant multiplier applied) is converted to a kWh or kVarh consumption value as appropriate.

Billing is a scheduled batch process in SAP IS-U and includes:

- creation of billing documents for invoicing
- generation of market messages for all meter readings
- Usage Factor update

The process for creation of billing documents for invoicing includes:

- determination of billing period
- determination and conversion of quantities e.g. kW to kVa
- determination of change dates and proration
- determination of rates and prices
- valuation of quantities with prices

3 Send Market Message

As a result of the meter point being billed a 300 or 305 message (estimated where no actual read obtained) is sent to the Supplier registered at that meter point.

4 Invoice at MPRN

Invoicing is a scheduled batch process in SAP IS-U, which supports determination and charging of VAT and generates posting documents for accounts receivable from the billing documents created in the billing process. As with the billing process, the invoicing process is also generated at individual MPRN level. The process also includes the updating of a special table that is subsequently used for the generation of the aggregated invoicing to suppliers.

The nightly invoicing run applies to all billing documents that were produced in the previous night's billing process. This enables any out-sorting or queries arising in the billing process to be validated or rectified in the following day, thereby, preserving the integrity of the overall billing and invoicing process.

5 Aggregated Invoice

Aggregated invoicing to suppliers is generated twice a month to produce Supplier Invoices – mid month and at month end. As described in the previous paragraphs, the scheduled billing and invoicing processes are created at MPRN level and result in the updating of a special table that provides the basis for the twice monthly cycle of supplier invoicing. The mid-month aggregated invoicing will include the first tranche of all MPRNs that were billed and invoiced since the last month end aggregated invoicing. The month end aggregated invoicing includes the second tranche of all MPRNs that were scheduled to be billed and invoiced since the last scheduled aggregated invoicing processing.

The following documentation is generated for transmission to suppliers via Secure File Transfer Service (SFTS) or Encrypted Email (EE) at each instance of aggregated invoicing:

- Supplier Invoice
- Credit Note (if applicable)
- DUoS Group Summary
- *MPRN Level Invoice Item Detail*
- Account Statement
- Dispute Summary
- Dispute Detail
- Remittance Advice

The *DUoS, Transaction & PSO Payment Process* document provides descriptions of each of these documents and includes sample documentation.

6 Send Backing Information behind invoice

This billing / invoicing / aggregated invoicing processing results in the generation of MPRN invoice line items on the *MPRN Level Invoice Item Detail* in respect of:

- Scheduled MPRN billing and invoicing of all scheduled meter readings including estimates where no actual reading available
- Final billing of any events necessitating termination of 'contracts'
- Billing / invoicing reversal including rebilling
- Manual billing of MPRNs for more or less than reflected through meter readings e.g. consumption adjustments.

The *MPRN Level Invoice Item Detail* is included as part of the documentation provided to supplier at step 5 via SFTS / EE.

3.2 Scheduled HH (Interval) Data Processing to Invoicing

Half hourly interval sites will be DUoS Billed on a bi-monthly basis.

Figure 3.3 below describes the approach to processing Half Hourly data from a data collection tool through to sending messages and producing an invoice. Each box in the diagram is described below.

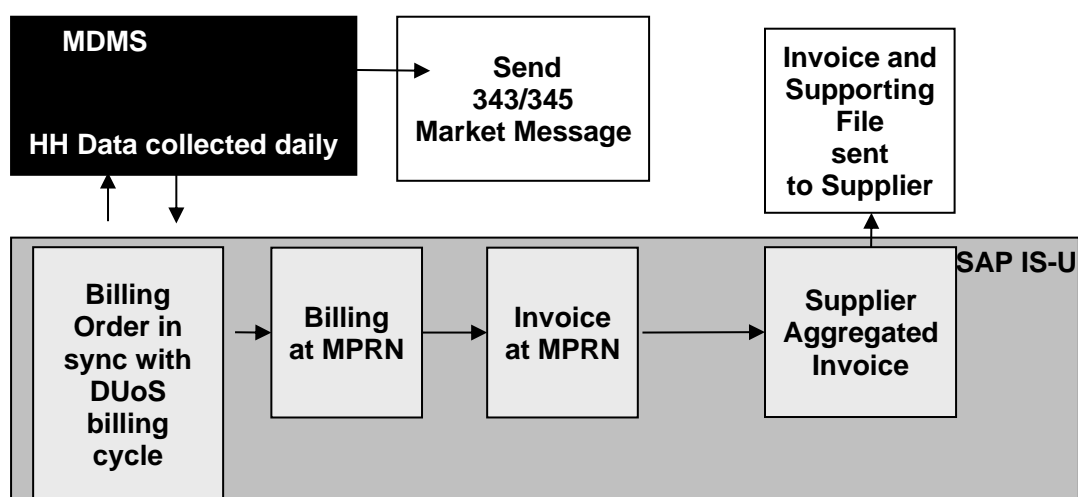

Figure 3.3: Half Hourly Interval Data Processing to Invoicing.

3.2.1 Data Collection and Billing at MPRN

Billing Orders in respect of Half Hourly interval Smart meter points are generated in SAP IS-U in accordance with the DUoS Billing Cycle Schedule. The DUoS Billing Cycle day refers to the day in a 41 working day cycle that a Half Hourly meter is due to be DUoS billed. This generation occurs on the evening of the third working day before the DUoS Billing Cycle day, the billing order will prompt a billing and subsequent invoicing document to be created based on the profile consumption between the last billing date (or contract start date) and the current billing date. This consumption will be allocated into three “buckets,” one per equivalent Smart Standard Tariff (SST) band. Where a billing document for a HH Interval site has been created using estimated data, when replacement actual data is received before DUoS aggregated billing, billing documents will be reversed, new billing and invoicing documents will be created based on the actual data.

The process for creation of billing documents for invoicing includes:

- determination of billing period
- determination and conversion of quantities e.g. kW to kWh
- determination of change dates and proration
- determination of rates and prices
- valuation of quantities with prices

Data is collected daily for Half Hourly (HH) sites, this data is validated and passed to Suppliers. A full set of data is required on D+1 and where actual data is unavailable it is estimated. Suppliers will receive the 343 Market Message detailing the HH intervals actual or estimated. Suppliers will also receive the 345 Market Message detailing the cumulative 24 hour register, where actuals are available. Where actuals are not available, the 345 Market Message will not issue.

3.2.2 Invoice at MPRN

Invoicing is a nightly batch process in SAP IS-U, which supports determination and charging of VAT and generates posting documents for accounts receivable from the billing documents created in the billing process. As with the billing process, the invoicing process is also generated at individual MPRN level

. The process also includes the updating of a special table that is subsequently used for the generation of the aggregated invoicing to suppliers.

The nightly invoicing run applies to all billing documents that were produced in the previous night's billing process. This enables any out-sorting or queries arising in the billing process to be validated or rectified in the following day, thereby, preserving the integrity of the overall billing and invoicing process

3.2.3 Aggregated Invoice

Aggregated invoicing to suppliers is generated twice a month to produce Supplier Invoices – mid month and at month end. As described in the previous paragraphs, the nightly billing and invoicing processes are created at MPRN level and result in the updating of a special table that provides the basis for the twice monthly cycle of supplier invoicing. The mid-month aggregated invoicing will include the first tranche of all MPRNs that were billed and invoiced since the last month end aggregated invoicing. The month end aggregated invoicing includes the second tranche of all MPRNs that were scheduled to be billed and invoiced since the last scheduled aggregated invoicing processing.

The following documentation is generated for transmission to suppliers via Secure File Transfer Service (SFTS) or Encrypted Email (EE) at each instance of aggregated invoicing:

- Supplier Invoice
- Credit Note (if applicable)
- DUoS Group summary
- *MPRN Level Invoice Item Detail*
- Account Statement
- Dispute Summary
- Dispute Detail
- Remittance Advice

The *DUoS, Transaction & PSO Payment Process* document provides descriptions of each of these documents and includes sample documentation.

3.2.4 Send Backing Information behind invoice

This billing / invoicing / aggregated invoicing processing results in the generation of MPRN invoice line items on the *MPRN Level Invoice Item Detail* in respect of:

- Scheduled MPRN billing and invoicing of all scheduled meter readings including estimates where no actual reading available
- Final billing of any events necessitating termination of 'contracts'
- Billing / invoicing reversal including rebilling
- Manual billing of MPRNs for more or less than reflected through meter readings e.g. consumption adjustments.

The *MPRN Level Invoice Item Detail* is included as part of the documentation provided to supplier at step 5 via SFTS / EE.

3.3 Scheduled QH Data Processing to Invoicing

QH metering can be installed in sites that are DUoS Group DG5, DG6, DG7, DG8, DG9, or DG10.

Figure 3.4 below describes the approach to processing QH data from the MV90 system through to sending messages and producing an invoice. Each box in the diagram is described below. A 30-day calendar month is assumed with (t) denoting the first day of the month.

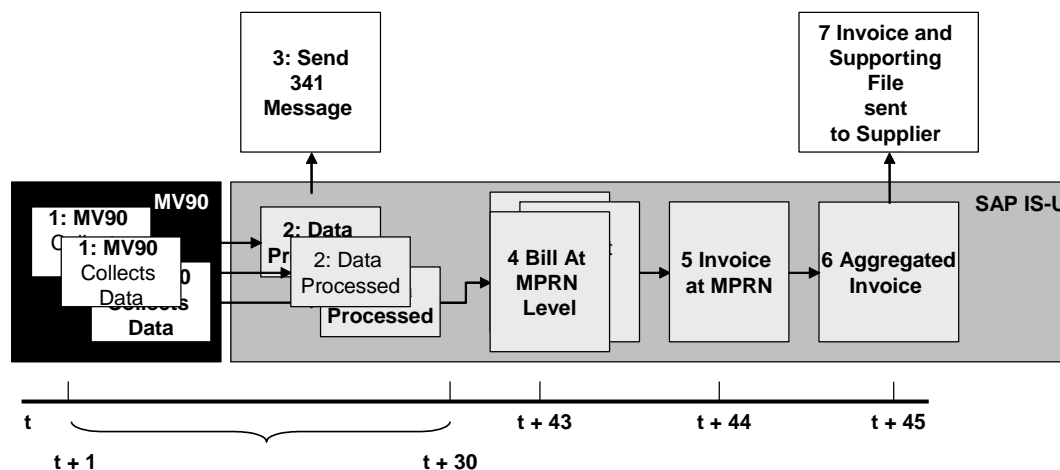

Figure 3.4: QH data processing to invoicing.

1 MV90 Collects Data

Designated sites are polled by MV90 on a nightly basis and interval data is retrieved from Quarter Hour meters.

MV 90 validates collected data against predetermined criteria. Where scheduled polling results in no data or invalid data, each effected MPRN is investigated. The interval data

for any day in respect of all QH designated sites must be made available to SAP IS-U within 10 working days under current agreements.

2: Data Processing

SAP will exercise its own validation processes of the transmitted MV 90 data. Data is processed and readings are passed to the appropriate market participants via the 341 Market Message. These messages are sent on a working day basis.

3: Send 341 message

Quarter Hourly data is sent to market participants following data processing. The sending of data to market participants does not depend on the SAP IS-U billing engine.

4: Billing at MPRN

QH data is DUoS billed at MPRN level. This billing process will happen once a month. Under current provisions, QH billing for any calendar month will be targeted for completion on the night of the 10th working day of the ensuing month.

The billing engine will create billing documents for invoicing. The process for creation of billing documents for invoicing includes:

- determination of billing period
- determination and conversion of quantities e.g. kW to kVa
- determination of change dates and proration
- determination of rates and prices
- valuation of quantities with prices
- creation of billing documents for invoicing

5 Invoice at MPRN

Although invoicing is a nightly batch process in SAP IS-U, QH data will be invoiced once a month (one day after the billing process). This enables any out-sorting or queries arising in the billing process to be validated or rectified in the following day.

As with the Non-Interval MPRN invoicing process, QH invoice processing will include VAT determination and application including generation of posting documents for accounts receivable from the billing documents created in the billing process. The process also includes the updating of a special table that is subsequently used for the generation of the aggregated invoicing to suppliers.

6 Aggregated Supplier Invoice

The aggregated invoicing run will be effected as soon as it is feasible following completion of the invoicing run at step 5. The mid -month aggregated invoicing described in the Non-Interval process will include all QH MPRNs that were scheduled to be billed and invoiced in respect of the previous calendar month as well as the first tranche of all Non-Interval MPRNs that were billed and invoiced since the last month end aggregated invoicing.

QH DUoS charges are included in the same aggregated Supplier Invoice as the Non-Interval data charges.

The resulting documentation from the aggregated invoicing processing is forwarded to suppliers via SFTS / EE at each instance of aggregated invoicing

7 Send Backing Information behind invoice

The detail supporting QH DUoS charges are included in the backing information behind the invoice and is included in the documentation that is forwarded to suppliers via SFTS / EE.

4. Business Events in the Networks Solution

This section will describe how the following key business events will be communicated and, where appropriate, billed in the Networks solution.

- Change of Supplier (CoS)
- Change of Legal Entity (CoLE)
- Change of DUoS Group (CoDG)
- Change of MIC
- Present less than Previous - Non Interval
- Customer Own Read (CoR)
- Special Reads
- Readings Associated with Meter Works
- Reversal of Non-Interval Reads
- QH and HH Replacement Reads
- Manual billing
- Smart Data Services

4.1 Change of Supplier (CoS)

A Change of Supplier will be processed through application of the following rules,

- A CoS will result in the termination of one 'contract' and the creation of a new 'contract'.
- Surcharge violation will be evaluated when the existing 'contract' is terminated for the old supplier.
- Surcharge violation will also be evaluated at the end of the next and subsequent scheduled billing period for the new supplier.
- Processes that result in a 'contract' termination (such as Change of Supplier) will always result in a usage factor update irrespective of the meter reading type, actual or estimate.

The CoS process is operated following receipt of Market Message 010 from a supplier. Once the change has been confirmed both the 'old' and 'new' suppliers will receive Market Message 105L and 105 respectively, to confirm the CoS and to provide the effective date.

For a QH and a HH metered MPRN, Market Message 331 issues to the 'new' supplier confirming the meter details.

A billing document is generated in SAP IS-U at the next scheduled billing run following completion of the CoS process and covers the final billing of the 'old' supplier from date of last scheduled billing (or other non-scheduled billing if applicable) plus one to the effective date for the CoS process.

For an Non-Interval metered MPRN, Market Message 310 issues to the 'old' supplier confirming closing reading. Market Message 320 issues to 'new' supplier confirming opening reading.

Invoicing will take place on the following night's scheduled invoicing run. This invoicing will be included in the next scheduled aggregated invoicing run.

The initial billing of the 'new' supplier will take place at the next scheduled billing for the MPRN. This will cover the period from the effective date (plus one) for the CoS to the date of the next scheduled billing (i.e. billing date to). The resulting MPRN billing and invoicing documents will be included in the next scheduled aggregated invoicing run.

Standing including capacity charges are prorated in accordance with the agreed market rule (see section 5.3). Surcharge 'violation' evaluations will be effected for both the final billing period of the 'old' supplier and the initial scheduled billing period for the 'new' supplier.

A Change of Supplier scenario is described in section 6.4 of this document.

4.2 Change of Legal Entity (CoLE)

A Change of Legal Entity will be effected through application of the following agreed market rules,

- For Non-Interval (Legacy Meter) DG1, DG2 and DG5 (<30kVa) the CoLE is processed for the required date (with a validated reading or with a system generated estimate) providing that it doesn't pre-date the date of the last scheduled or non-scheduled DUoS billing for the given MPRN. Should the required date be on or pre-date the last DUoS billing date, the CoLE will be processed for the message received date to a system-generated estimate. Additionally, should no required date be provided, then the CoLE will take effect for the message received date to a system-generated estimate.
- For DG5 (>=30kVa), DG6, DG7, DG8, DG9 and DG10, the effective date will be the required date. If no reading is provided for Non-Interval non-Max Demand (MD) meter points or where a provided reading fails validation, then a system-generated estimate reading will be used. For Non-Interval Maximum Demand (MD) meter points the CoLE will be processed for a reading obtained in response to a special reading request or a previous actual scheduled read if a subsequent read has not been obtained. In the case of QH sites, the CoLE will be processed for the required date. Should no required date be provided, the CoLE will be enabled on the date that the DSO receives the message

Processing of CoLE where Smart meters are installed;

- For a Smart Non-Interval site where remote reading is feasible, a Supplier can provide the required date for CoLE. If the required date is on or before the last billing date CoLE will complete on the date the Market Message was received.
- Where the required CoLE date is the same as the periodic read date with billing, the CoLE will be effective from the required date + 2. Where a Supplier provides a reading and remote reading is obtained the Supplier reading will be rejected using MM303R. If an ESN obtained read is not available the supplier provided read will be used (if plausible) to complete the CoLE and be provided on MM300 to the Supplier.
- At a Smart Interval site, it is mandatory for a Supplier to provide a required date for the Change of Legal Entity. The Supplier will not be asked to provide a reading, if a reading is provided this reading will be rejected using MM303R as this site can

be read remotely by ESNB. The Change of Legal Entity will be recorded as at the date of the required date.

- CoLE for a Smart Interval site can be backdated up to 24 months, where the site has remained at Smart Interval for the entire time requested, and provided the required date does not go back before a previous Move In (e.g. reconfiguration from Non Interval to Interval, CoS, CoLE.).
- The CoLE process is operated following receipt of Market Message 016 from a supplier.

A billing document is generated in SAP IS-U at the next scheduled billing run following completion of the CoLE process and covers the final billing of the 'old' legal entity from date of last scheduled billing (or other non-scheduled billing if applicable) plus one to the effective date for the CoLE process. Invoicing will take place on the following night's scheduled invoicing run. This invoicing will be included in the next scheduled aggregated invoicing run.

A CoLE will result in the termination of one 'contract' and the creation of a new 'contract'.

Surcharge violation will be evaluated when the existing 'contract' is terminated for the old customer and again at the end of the scheduled billing period for the new end customer.

Processes that result in a 'contract' termination (such as Change of Legal Entity) will always result in a usage factor update irrespective of the meter reading type, actual or estimate.

Market Message 300 issues to supplier confirming readings for the CoLE process for the 'old' legal entity. This reading also serves as the opening reading for the 'new' legal entity.

The initial billing of the 'new' legal entity will take place at the next scheduled billing for the MPRN. This will cover the period from the effective date (plus one) for the CoLE to the date of the next scheduled billing (i.e. billing date to). The resulting MPRN billing and invoicing documents will be included in the next scheduled aggregated invoicing run.

Standing including capacity charges are prorated in accordance with the agreed market rule. Surcharge 'violation' evaluations will be effected for both the final billing period of the 'old' legal entity and the initial scheduled billing period for the 'new' legal entity.

There are additional sundry items relating to Change of Legal Entity that are not outlined in this document but can be viewed in MPD 25. A Change of Legal Entity scenario is described in section 6.5 of this document.

4.3 Change of DUoS Group

QH& Non-Interval (>= 30kVa):

A change of DUoS Group for QH and Non-Interval customers in the grouping DG5 (>=30kVa), DG5A, DG6, DG6A, DG7, DG7A, DG8, DG8A, DG9, DG9A and DG10 will require a new 'contract' for the allocation of the new DUoS Group with termination of the old 'contract' for the old DUoS Group. The Change of DUoS Group will be effective from the start date of the new 'contract' under agreed market rules. Market message 301 will

be automatically triggered to communicate the change of DUoS Group to the registered supplier.

Where a registered customer is moving from Non-Interval (<30kVa) to QH or Non-Interval (>=30kVa), the change of DUoS Group will also be effective from the start date of the new 'contract'. Market message 301 will also issue to the registered supplier to communicate the change of meter point characteristics which includes change of DUoS Group.

Where an MCC change also occurs in conjunction with a DUoS Group change (>=30kVa), Market Message 332 is used to communicate the changed meter details including readings for a Non-Interval meter point and MM331 is used for a QH meter point.

A billing document is generated in SAP IS-U at the next scheduled billing run following the completion of the Change of DUoS Group process and covers the final billing of the 'old' DUoS Group charges from date (plus one) of last scheduled billing (or other non-scheduled billing if applicable) to the effective date for the Change of DUoS Group process. Invoicing will take place on the following night's scheduled invoicing run.

The initial billing of the 'new' DUoS Group charges will take place at the next scheduled billing for the MPRN. This will cover the period from the effective date (plus one) for the Change of DUoS Group to the date of the next scheduled billing (i.e. billing date to). The resulting MPRN billing and invoicing documents will be included in the next scheduled aggregated invoicing run.

Standing charges, including capacity charges are prorated in accordance with the agreed market rules. Surcharge 'violation' evaluations will be effected for both the final billing period applicable for the 'old' DUoS Group and the initial scheduled billing of the 'new' DUoS Group charges.

Non-Interval and HH DG1, DG2 & DG5 (< 30kVa):

It should be noted that a change of DUoS Group for DG1, DG2 and DG5 (<30kVa) will be effective from the 1st day of the current billing period for changes within this grouping or where a non-scheduled billing event has occurred since the last scheduled billing, the change of DUoS Group will be effective from the effective date plus one of this event. DUoS Group changes within this grouping are permitted without a new connection agreement and include no 'contract' termination. There is no non-scheduled billing involved. Market message 114 will be issued to the registered supplier for the relevant MPRN to communicate the changes in customer details.

Charging in respect of the new allocated DUoS Group will apply from the 1st day of the current billing period and will be included in the next scheduled billing for the MPRN involved. *The MPRN Level Invoice Item Detail* supporting the Supplier Invoice for this MPRN will, therefore, reflect the new charging regime for standing and energy consumption for the total billing period where the change of DUoS Group has taken effect within the currency of this period.

Change of DUoS Group scenarios are described in section 6.6 of this document.

4.4 Change of MIC

Changes of MIC which are requested in conjunction with a change of 'contract' associated with CoDG (>=30kVa) will be effective from the start date of the new 'contract'. Please

refer to Section 4.3 (CoDG) for detailed treatment of this event in the billing / invoicing and aggregated invoicing processes.

However, a change of MIC requested on its own for an existing customer will be affected for DUoS billing from the 1st day of the next billing period, subject to a new connection agreement being signed where necessary. This means that no change of 'contract' is involved. This will apply to both QH and Non-Interval customers and will enable surcharge violations to be effected for the full scheduled billing period. Market Message 301 issues to the registered supplier to communicate the change of MIC of the concerned MPRN.

A Change of MIC scenario is described in section 6.7 of this document.

4.5 Present less than Previous - Non-Interval

The term "present less than previous" describes a situation where an actual read is less than a previously used estimate. The system provides for the automatic re-estimation of previous over-estimates. Therefore, the previously used estimate will be withdrawn and a new estimate provided for that date. The new estimate will be based on the present actual read that is being recorded. This action will be communicated to a Supplier through the sending of a 300W message for the estimate that is being withdrawn, followed by a 305 message for the new estimate that has been interpolated from the present actual being processed.

Any previous estimates that are greater than the present actual will be withdrawn. Figure 4.1 below describes a situation where an actual is received resulting in the withdrawal of two previous estimates.

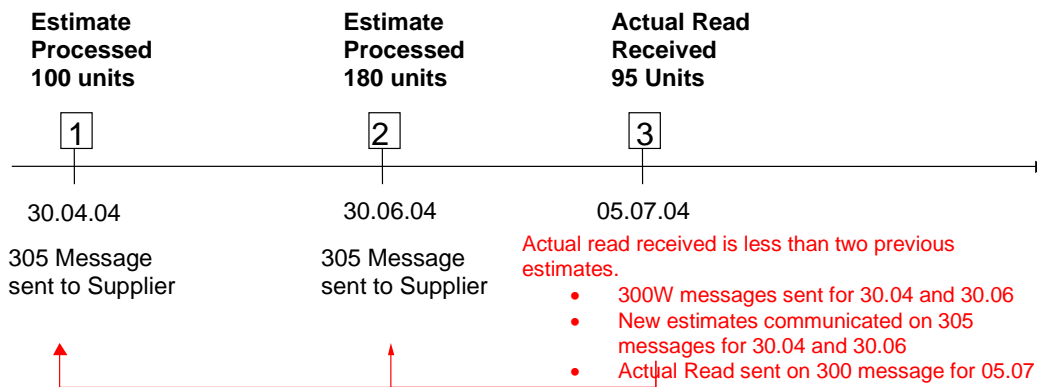

Figure 4.1: Processing an Actual read that is less than previous estimates for Non-Interval site manually or remotely read.

Step 1 in the time line described in figure 4.1 shows a full set of estimated readings at a meter point being estimated and processed for a billing period resulting in a 305 message being sent to the Supplier. 305 Market Message will not issue for Interval Half Hourly sites. The estimates would also be used by DUoS billing.

Step 2 occurring on the 30.06.2004 again uses a complete set of estimates for this site. As with step one, the estimated readings would be communicated to the Supplier via the 305 Market Message. The estimated reads are also used in DUoS billing.

Step 3 in figure 4.1 describes a set of actual reads being processed for this site. The actual reads are less than the previously processed estimates.

To facilitate the successful processing of the actual, the previous estimates that are greater than actual will be reversed. This will result in the sending of a 300W message for the estimates processed on the 30.04.2004 and a separate 300W being sent for the estimates processed on the 30.06.2004. Since both sets of estimates have been processed through DUoS billing, they would have been communicated to the Supplier in the supporting information behind the invoice. The next invoicing run will show a reversal line item for each set of estimates. This subject is dealt with in more detail in section 5.7 *Billing / Invoicing Reversals*. With the benefit of the actual read received, new estimates are produced for the dates 30.04.2004 and 30.06.2004. For each new set of estimates a 305 Market Message is sent to the Supplier. A 300 message is sent to the Supplier for the set of actual reads processed on the 05.07.2004.

A present less than previous situation can occur for any actual read processed (e.g. meter works, Change of Supplier, Customer Own Read).

An example scenario is played out in section 6.2 of this document

It is worth noting that where a site has a number of registers and where combinations of estimated and actual reads are returned for a given business process, then all reads will be treated as actual. Therefore, the Supplier will receive a 300 message.

4.6 Customer Own reads (CoR)

Customers can supply own reads to the Data Collection function through various channels in response to no access cards left for scheduled meter reading calls. Where communications are unavailable, a customer own read will be accepted for MCC01 and MCC16 sites. Customer Own reads will not be accepted for Interval sites. CoRs can also be furnished from customers via their supplier using Market Message 210 (or 010 in the case of CoS). CoRs will be dealt with as follows:

- Where CoR relates to a closed meter reading / billing period, (i.e. the meter read date of the CoR pre-dates the last DUoS billing), the reading will be rejected.
- Should the CoR fall within a current meter reading / billing period that is still open and can be matched open periodic meter reading order (e.g. 30.04.04 – 12.05.04 period in the example below), the CoR will be recorded as an actual meter read to fulfil the open periodic meter reading order, followed by the normal **scheduled** DUoS billing, invoicing and aggregated invoicing to supplier
- Where CoR relates to an open meter reading / billing period and cannot be matched to an open periodic meter reading order, then the meter reading will be processed as an out of cycle read (e.g reading supplied on the 13.05.04 in the example below).
 - where it is less than the DUoS billing reading, it will be processed with generation of market message 300 and with the update of usage factors. Furthermore, billing reversal and re-estimation of the overestimated DUoS billing reading will occur.
 - where the COR is greater than the DUoS billing reading, it will be processed with generation of market message 300 and update of usage factors. No DUoS billing will be effected, for this advance in reading.

The processes described below are applicable to CoRs provided directly by customers or through their suppliers.

Example

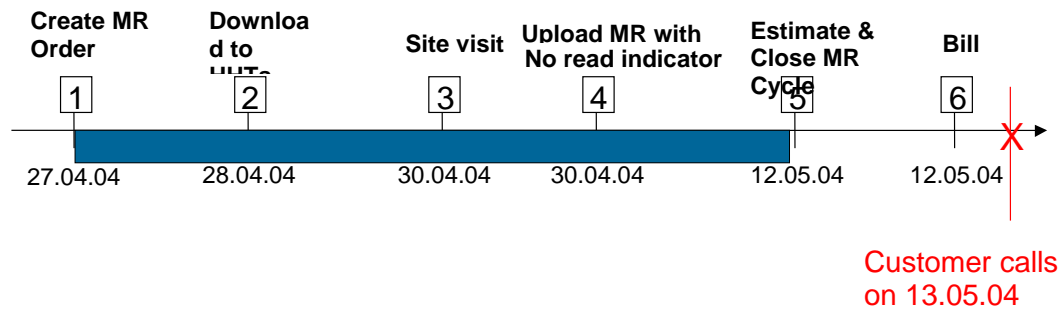

Figure 4.2 CoR in respect of a closed billing period

Meter Reader visited installation on the 30.04.04 (scheduled read date) and left a card due to no access. The scheduled reading is automatically estimated and billed on the 12.05.04 (end of meter reading / billing period) with a value of 100 for the scheduled read at 30.04.04. The customer rings on the 13.05.04 and communicates a reading of 90.

This will be processed as follows:

- Withdrawal of affected meter reading for 30.04.04 for 100 – Market Message 300W
- Reversal of billing and invoicing document in respect of the MPRN invoice line
- Re-estimation of affected meter reading for 30.04.04 for 100 – Market Message 305
- Generation of Market Message 300 to registered supplier confirming plausible own reading
- Generation of adjustment lines on MPRN Level Invoice Item Detail for next Supplier Invoice

Where the original MPRN invoicing line and subsequent reversal line occur in the same aggregated invoicing period, the replacement invoicing line will only be displayed on the aggregated invoice that issues to supplier. The original MPRN invoicing line and the corresponding invoice reversal line will not be displayed as they cancel each other.

If the CoR is not less than the previously billed reading, the following occurs:

- Generation of Market message 300 to registered supplier confirming plausible own reading
- Usage factor update
- No DUoS energy billing as DUoS follows the billing schedule

A Customer Own read scenario is described in section 6.3 of this document.

4.7 Special Reads

Special reads are out-of-cycle reads that can be requested by suppliers, data collector, etc. Should the special read be requested by supplier to support a CoS or CoLE, then it will be treated from a DUoS billing perspective in accordance with Sections 4.1 or 4.2 as appropriate.

Special reads requested by suppliers or by data collector, etc for other purposes will be recorded as actual meter reads if deemed plausible and if higher than previous estimated read, and will result in:

- Generation of Market message 300S to registered supplier
- Usage factor update
- No DUoS energy billing as DUoS follows the billing schedule

Should the special read be less than the previous estimated read, it will result in:

- Generation of Market message 300S to registered supplier
- Withdrawal of any affected meter readings – Market message 300W
- Reversal of billing and invoicing documents in respect of the MPRN invoice lines for all affected readings.
- Re-estimation of affected meter readings – Market message 300
- Generation of adjustment lines on MPRN Level Invoice Item Detail for next Supplier Invoice.

4.8 Meter Works

Readings in respect of the following non-scheduled events are passed to the billing engine

- Readings in respect of de-energisation and re-energisation
- Start readings for meter configurations pertaining to the installation of new meters or exchanged meters
- Start readings for additional meter configurations
- Final readings for removed meters

These readings are communicated to suppliers via appropriate market messages. Usage factors are updated. However, no DUoS billing occurs at this point.

4.8.1 Readings for De-energisation

Readings in respect of de-energisation of Non-Interval meter points are input to SAP IS-U, whereupon, they are validated. Following validation, plausible readings are passed to the billing engine. Market Message 106D issues to registered supplier of a QH meter point or a HH Interval site informing of the de-energisation event. Market message 306 issues to the registered supplier to confirm de-energisation and associated reading. Where a meter is removed at de-energisation of a Non-Interval meter point, Market Message 332 issues to the registered supplier. No MM 306 is sent in this case. Where a QH or HH meter is removed at de-energisation MM 331 issues to the registered supplier.

Whilst no DUoS energy billing generally occurs at the time of processing of these out of cycle reads, the readings will be subsequently used at the next scheduled billing of the relevant MPRNs to calculate energy consumption for the scheduled billing period. In

accordance with agreed market rules, standing and capacity charges will continue to apply for the balance of the scheduled billing period and subsequent billing periods pending re-energisation or de-registration.

4.8.2 Readings for Re-energisation

Readings in respect of re-energisation of Non-Interval meter points are again input to SAP IS-U, whereupon, they are validated. Following validation, plausible readings are passed to the billing engine. Market Message 106E issues to registered supplier of a QH and HH meter point informing of the re-energisation event. Market message 307 issues to the registered supplier to provide notification of the re-energisation and the associated reading. Where a meter is installed at re-energisation of a Non-Interval meter point, Market Message 332 issues to the registered supplier. No MM 307 is sent in this case. Where a meter is installed at re-energisation of a QH or HH meter point MM 331 is issued to the registered supplier.

Whilst no DUoS energy billing generally occurs at the time of processing of these out of cycle reads, the readings will be subsequently used at the next scheduled billing of the relevant MPRNs to calculate energy consumption from the date of re-energisation to date of the scheduled billing period. In accordance with agreed market rules, standing charges will continue to apply for the duration of any de-energisation portion of any scheduled billing period.

4.8.3 Readings for Meter Configuration Changes

Supplier request changes to metering configuration for a meter point via Market Message 030 through DSO. This process includes requests for additional meters and meter exchanges. It also includes DSO initiated changes to metering e.g. as part of a planned replacement programme. Should the proposed change of metering configuration result in a change of MIC, the process as described in Section 4.4 applies. The necessary meter works are affected by the DSO/MO, following receipt of appropriate documentation from customer, where applicable.

If a Smart meter is installed and a CTF (Comms Technically Feasible) rating of 1 or greater is proven, the Supplier can request an MCC change to Smart Data Services on the MM013, MM010, MM016 or MM017.

Readings in respect of meter configuration changes of Non-Interval (remote and manually read) meter points are again input to SAP IS-U, whereupon, they are validated. Following validation, plausible readings for old and new meters are passed to the billing engine. Market message 332 issues to the registered supplier communicating the new or changed meter details including associated readings. Market message 331 issues to registered supplier in respect of QH and HH meter point configuration changes.

Where a like for like meter exchange takes place the consumption for the billing period will be determined by summing consumption for the removed meter and new meter. The closing reading for a removed meter will be used in determining final consumption and will be included in the next scheduled billing of the meter point.

In respect of Non Interval sites where final readings from removed meters or de-energised readings are less than previous estimated readings, it will result in:

- Reversal of billing and invoicing documents in respect of the MPRN invoice lines for all affected readings.
- Withdrawal of any affected previous overestimated readings – Market message 300W
- Re-estimation of previous overestimated meter readings – Market message 305
- Generation of Market message 332 to registered supplier confirming plausible final reading for removed Non-Interval meter
- Generation of adjustment lines on MPRN Level Invoice Item Detail for next Supplier Invoice.

A meter exchange is described in section 6.8 of this document whilst a de-energisation is described in section 6.9.

4.9 Reversal of Non-Interval Readings

Within the Networks solution, the processing and communication of Non-Interval reads are integrated to the billing of DUoS charges at MPRN level. Section 5.7 *Billing / Invoicing Reversals* communicates how Non-Interval billing reversals will be dealt with from a DUoS perspective. This section will explain how messaging will communicate the reversal/withdrawal of a read.

Whenever Networks complete a process that requires a meter reading, a market message is sent to the appropriate Supplier/s. If that process were reversed a “W” message will be sent to the appropriate Supplier/s. A business reference number is communicated in the message with the relevant Non-Interval read. If the process were reversed the “W” message sent to communicate the reversal will hold the same business reference number. Therefore, the business reference number can be used by the Supplier to associate the original business process and the withdrawal of that business process.

The figures below provide two examples of how reversals will be communicated.

Figure 4.3A describes how a meter read withdrawal would be communicated.

Figure 4.3B describes how a meter works withdrawal would be communicated.

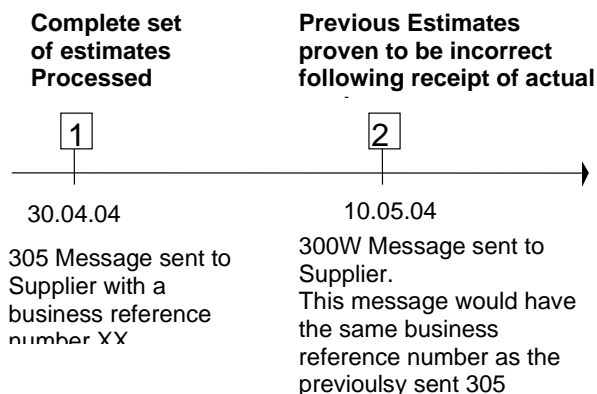

Figure 4.3A : A withdrawn estimated read communicated to a Supplier

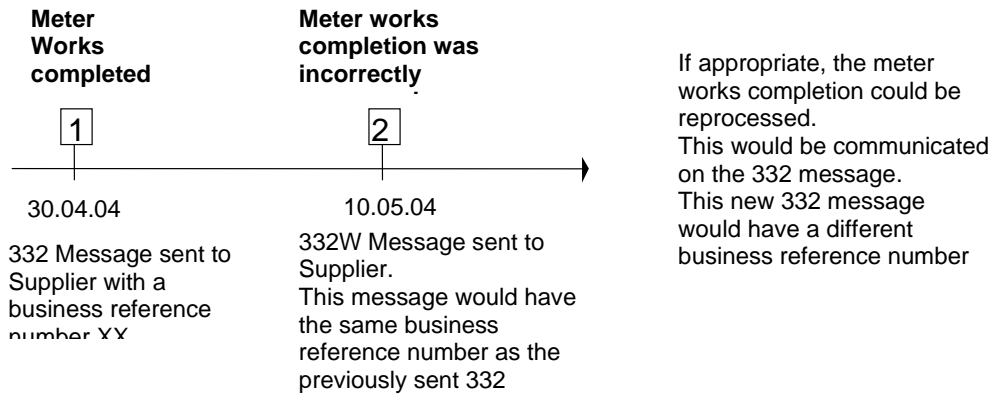

Figure 4.3B: A withdrawn Non-Interval meter works completion message

4.10 QH and HH Replacement Reads

When QH and HH reads are processed by Networks they are sent to market participants via the 341, 342 and 343 Market Messages. It is possible that the interval data communicated for a given day will need to be replaced. If this occurs, a Supplier will receive a complete set of readings for the given day on the 341, 342 and 343 Market Messages. There is no withdrawal message to withdraw the reads originally communicated.

This situation could arise for QH sites if ESB Networks has estimated a set of reads for a site on a given day. These estimates will be communicated to the Supplier on the 341 or 342 Market Message. When the actual reads are received for the day that was previously estimated, they will be communicated to the Supplier in a new 341 or 342 Market Message.

If replacement QH reads are to be sent, the Supplier will be contacted by Networks to advise that the 341 or 342 message will be sent with replacement reads. Note:- This will be a resend of the data for the complete day in question.

In the case of Half Hourly Interval data, it is possible that Half Hourly data communicated for a given day will need to be replaced. Replacement data will be sent to Market Participants via Market Message 343, with a version flag. There is no withdrawal message to withdraw the reads originally communicated. Where a full suite of actual interval reads have been received and sent to Market Participants via MM 343, this will be followed by MM345 reflecting the Smart HH Cumulative Register reading.

4.11 Manual Billing

Manual billing will be typically utilised to bill MPRNs for adjustments. This typically will cover the following scenarios:

- metering malfunction (time switches, damaged meters, stopped registers)
- revenue protection activities
- non-register rate amendments (standing and capacity charges)

Values are entered manually to SAP IS-U. A billing document will also be generated following processing of the manual billing. All manual billing will have a separate line on the backing documentation (i.e. the *MPRN Level Invoice Item Detail*) that will support the aggregate invoice. This could be a debit or credit line depending on the nature of the transaction.

Following quantification of unrecorded consumption for the affected MPRN, details will be communicated offline by ESB Networks to the customer and in agreement with their registered supplier.

4.12 Smart Data Services

Customers can request Smart Data Services through their Supplier. There are two different types of Smart Data Services, Interval and Non-Interval. Interval relates to Meter Configuration Code MCC12 and Non-Interval refers to MCC16.

Customers can request Smart Data Services, MCC12 or MCC16, on the following Market Messages, via their Supplier:

- Registration Request (MM010)
- Customer Details Change (MM013)
- Change of Legal Entity (MM016)
- Meter Point Status Change Request (MM017)

The provision of Smart Data Services is dependent on the level of communication available at the site of the MPRN. This level is known as Comms Technically Feasible (CTF).

CTF is a check that ESB Networks will perform regularly on each meter installation, to establish the reliability of communications from the smart meter to the Head End System across the 2G telecommunications network.

CTF will be used by ESB Networks to determine the method for reading and managing the meter (remote or manual).

For MCC16 (Non-Interval) a CTF value of 01/ 02/ 03/ 04 is required (New Connections can be registered as MCC16 and do not require a valid CTF), and for MCC12 the CTF value must be 03/04.

A CTF update will result in the issuing of MM114 (the message status code will be "A" (Advice)) to the registered Supplier notifying them of the current CTF value. ESB

Networks will reject requests from Suppliers for Smart Data Services that cannot be supported by the CTF value recorded for the MPRN.

CTF Value	Description
01	Communications proving for the MPRN has failed –only manual reading is possible for this meter
02	The meter can be remotely read but not reliably
03	The meter can be remotely read regularly but not every day
04	The meter can be remotely read every day with very good reliability

**1. Supplier requests Meter Configuration change from MCC01 to MCC12
CTF value must be at 03 or 04.**

ESB Networks will create a service order to remotely process the MCC change. Readings from 23:59 the previous day will be used to process the MCC change. ESB Networks will issue MM331 with opening meter details, and MM332 will issue with closing readings for the old MCC. These readings are passed to the billing engine, however no DUoS Billing occurs at this point.

**2. Supplier requests Meter Configuration change from MCC01 to MCC16.
CTF value is at 02, 03 or 04.**

ESB Networks will create a service order to remotely process the MCC change. Readings from 23:59 the previous day will be used to process the MCC change. ESB Networks will issue MM332 with both the closing and opening readings. The closing reads will appear as read reason '16' and the new reading after meter re-configuration will appear as read reason '11' on separate segments of MM332. These readings are passed to the billing engine , however no DUoS Billing occurs at this point.

**3. Supplier requests Meter Configuration change from MCC01 to MCC16
CTF value is at 01.**

ESB Networks will create a service order to process the MCC change. A ESB Networks Technician will call to site and complete MCC Change. ESNB will issue MM332 with the closing and opening readings. The closing reads will appear as read reason '16' and the new reading after meter re-programing will appear as read reason '11' on separate segments of the MM332 These readings are passed to the billing engine , however no DUoS Billing occurs at this point.

5. Key Billing Concepts and Principles

5.1 Distribution Use of System (DUoS) Tariffs

Annual Schedules of Distribution Use of System Charges are approved by CRU and published on the CRU web site.

5.2 Billing Periods

Scheduled MPRN billing and invoicing for Non-Interval sites and HH sites will be affected every two months, based on an assigned meter reading and billing schedule. The length of the billing period will generally be of the order of the 58 to 64 calendar days with an average target of 61 days, but they can vary upwards and downwards. For example, where change of cycle is assigned to individual MPRNs, a once off change in the billing period can lead to an increase or decrease of up to four weeks in the billing period. Abnormalities in billing period lengths can also occur due to Christmas and Easter bank/public holidays.

Scheduled MPRN billing and invoicing for QH sites will be affected each month covering the previous calendar months readings.

Billing periods in respect of non-scheduled reading events will vary in accordance with the effective date for processing of the event involved. Where a change of 'contract' is encountered the initial billing of the 'new contract' will take place at the next scheduled billing for the MPRN and will cover the period from the effective date (plus one) for the event involved to the date of the next scheduled billing (i.e. billing date to). The final billing of the 'old contract' will generally apply from date of last scheduled billing (or other non-scheduled billing if applicable) plus one to the effective date for the event involved. MPRN invoicing will take place on the following night's scheduled invoicing run. The resulting MPRN billing and invoicing documents will be included in the next scheduled aggregated invoicing run.

The billing period for each MPRN billing and invoicing reflected on the Supplier Invoice will be displayed on the *MPRN Level Invoice Item Detail* in the Billing Date From column (Field 8) and the Billing Date To (Field 9). The Billing Date From is the date from which the billing period for the item became effective, whilst the Billing Date To represents the date to which the billing period for the item was effective.

5.3 Proration

Prices for Standing and Capacity Charges will be specified per annum and prorated on a daily basis.

See Tables below for example of application of formula.

Table 1

Standing Charge	€12/Annum
Bill from Date:	01/06/2003
Bill to Date:	28/07/2003
Bill Period Length	58 Days
Standing Charge:	$12/365$ (or 366 leap year) *58 = €1.906 (Rounded billing value €1.91)

Table 2

Standing Charge	€12/Annum
Move in Date:	11/06/2003
Bill to Date:	28/07/2003
Bill Period Length	48 Days
Standing Charge:	$12/365$ (or 366 leap year) *48 = €1.578 (Rounded billing value €1.58)

Table 3

Standing Charge	Till 30/06/03: €12/annum From 01/07/2003: €24/annum
Bill from Date:	01/06/2003
Bill to Date:	28/07/2003
Bill Period Length	A = 30 days B = 28 days
Standing Charge:	$(12/365(\text{or } 366 \text{ leap year}) *30) + (24/365(\text{or } 366 \text{ leap year}) *28) = (\text{€}0.986 + \text{€}1.841)$ (Rounded billing value €2.83 i.e.€0.99+€1.84)

Normal rounding conventions will be applied to the output values – billing value will be displayed to two places of decimal with the second digit value after the decimal rounded downwards for values (<0.5) and upwards for values (>=0.5). Where multiple billing periods are employed, rounding will be affected to the output value for each time period – see Table 3.

5.4 Surcharges

Maximum Import Capacity (MIC) and Low Power factor (LPF) surcharges are a component of the Distribution Use of System Charges and where applicable are an additional charge to the customer and are controllable by the customer. The surcharges are applicable where customer:

- exceeds their contracted MIC
- has reactive or 'wattless' power above a defined proportion of active power

5.4.1 Maximum Import Capacity Surcharge

A customer's MIC (in kVA) is the maximum electrical capacity of the connection point agreed between ESB as Distribution System Operator and the customer. The MIC surcharge is applied to Non-Interval customers in every two monthly billing period and to QH customers on a monthly basis. The Surcharge is applied when the customer exceeds their contracted MIC. There is no proration in the application of the surcharges for any billing period. They are applied in full to part billing periods e.g. CoS, CoLE. There is no carry forward to the next period. The purpose of the surcharge is to discourage users of the distribution system from exceeding their MIC, which has considerable safety implications.

If MD peak measurement (KVA) > MIC **then** pay Surcharge

Excess Capacity (kVa) = Subtract MIC from peak measurement

QH MIC Surcharge = Excess Capacity (kVa) * 5*Capacity Charge Rate

Non-Interval MIC Surcharge = Excess Capacity (kVa) * 6 *Capacity Charge Rate

KVA is calculated as follows,

QH Installations

The Maximum Demand (MD) for QH installations (DG7 – DG10) is calculated for each quarter-hour set of figures in kW and kVAr on a 24/7 basis for the billing period and the highest MD in kVA for the billing period is selected as the MD value. Maximum Demand is established for each quarter-hour by the following conversion:

$$\mathbf{kVA} = \sqrt{\mathbf{kW^2 + kVAr^2}}$$

The Maximum Demand (MD) for QH DG6 installations is calculated for each quarter-hour set of figures in kW and kVAr on a 08h00 – 21h00, Mon-Fri basis and the highest MD in kVA for the billing period is selected as the MD value. Maximum Demand is established for each qualifying quarter-hour by the following conversion:

$$\mathbf{kVA} = \sqrt{\mathbf{kW^2 + kVAr^2}}$$

*Non-Interval Installations – DG6**

The MD for Non-Interval installations is calculated from the MD figure in kW divided by the power factor which is calculated from the kWh & kVArh figures for that billing period.

Maximum demand is measured over the two-month billing period between 08h00 – 21h00, Mon-Fri.

The measured demand in kW is converted to kVa by applying the following formula,

$$\mathbf{Power\ Factor\ (PF)} = \frac{\mathbf{A}}{\sqrt{\mathbf{A^2 + B^2}}}$$

Where

A = kWhs (Total of Day + Night for the billing period)

B = kVArh (Total for the billing period)

The MD in kVa is equal to the MD in kW divided by the PF

$$\mathbf{MD\ in\ kVA} = \frac{\mathbf{MD\ kW}}{\mathbf{PF}}$$

Where no wattless reading is available an assumed Power Factor of 0.95 is used in converting the measured demand in kW to kVA

MIC Surcharge details are reflected on the *MPRN Level Invoice Item Detail* as follows

Field 18 – Maximum Import Capacity

The MIC is the Maximum Import Capacity in kVA which has been agreed by the customer in the connection agreement with the DSO.

Field 19 – Max kVA

This is the recorded max kVA for the MPRN for the billing / invoicing period

Field 20 – MIC Surcharge

This is the penalty surcharge where a customer exceeds the agreed level of MIC.

5.4.2 Low Power Factor Surcharges

The Low Power Factor Surcharge applies when the metered kVAh is more than one third of the metered kWh in any two monthly billing period (Non-Interval) and in any monthly billing period (QH).

The Low Power Factor Surcharge is calculated as follows,

Add all active register values = Sum (Active)

Add all reactive registers = Sum (Reactive)

If Sum (Reactive) > 1/3 (Sum (Active))

Then,

Subtract 1/3 Sum (Active) from Sum (Reactive) = Excess Reactive

LPF Surcharge = Excess Reactive * LPF Surcharge Price

QH Installations

- The low power factor surcharge will apply when the metered kVAh is more than one third of the metered kWh (in any monthly billing period).
- The charge is applicable to the kVAh in excess of one third of the kWh.
- There is no pro-rata application of surcharges; they are applied in full, based on consumption in the measured period.

Non-Interval Installations

- The low power factor surcharge applies when the metered kVAh is more than one third of the metered kWh (in any 2 monthly billing period).
- The charge is applicable to the excess of one third of the kWh.
- There is no pro-rata application of the surcharge, it is applied in full, based on consumption in the measured period.

LPF Surcharge details are reflected on the *MPRN Level Invoice Item Detail* as follows:

Field 10– Day kWh consumption
Field 12 – Night kWh Consumption
Field 14 – 24hr kWh Consumption

Display the total kWh energy consumption for the MPRN for the billing period for day, night and 24hr respectively

Field 21 – Reactive Energy kVArh
Reactive consumption as measured at the meter point for the billing period both QH and Non-Interval

Field 22 – Power Factor Surcharge
This is a penalty for Low Power Factor (LPF).

5.5 Tariff Price Changes

Annual schedules of Distribution Use of System Charges are approved by CRU and published on the CRU web site. The effective date for the new charges has been the 1st day of October to the 30th September of the following year.

As price increases will normally occur within MPRN billing periods for both scheduled and non-scheduled Non Interval and HH billing and invoicing processing, the application of price changes will be affected as follows:

Standing charges and capacity charges in respect of the MPRN billing period will be time sliced with the old charges applicable for the period (number of days) covering the Billing From date up to and including the 30th of September. The new charges will be applicable for the period (number of days) from the 1st October up to and including the Billing To Date.

The calculated day, night ,24hr kWh consumption and Standard Smart Tariff for the billing period will be time sliced for the billing period by estimating consumption proportionately for both periods using the standard estimating algorithm. Energy charges will be calculated through application of old and new prices to the estimates derived for both time slices determined for the billing period.

The application of tariff price changes for QH billed meter points is more straight-forward as changes are usually applicable from the first day of the calendar month.

A tariff price change scenario is described in section 6 of this document.

5.6 Energy Consumption Determination

The reading advance (i.e. the difference between the current and the previous valid reading) for each meter register that accumulates consumption for billing and settlement purposes is converted to a kWh consumption value. Meter clock overs will be automatically handled by SAP IS-U to reflect actual consumption. Energy consumption by Day, Night, 24hr and Standard Smart Tariff for each billing period is determined and reflected on the *MPRN Level Invoice Item Detail* as follows:

Field 10 – Day kWh Consumption – (08.00 – 23.00)
The Day rate energy consumption, if applicable, recorded in kWh that was determined for the current billing /invoicing period of the MPRN provided in the line item charge. For Non-Interval MPRNs, this would be determined by the system by

deducting the last meter reading that was subject to a billing / invoicing process from the current scheduled meter reading or any reading provided to facilitate termination of any contract. Multipliers are applied where applicable. Where multiple day/night registers are encountered at any MPRN, the total day consumption is determined by aggregating the derived consumption determined for each day register for the billing period. For QH MPRNs the day consumption for the period is determined based on all the 15-minute profile meter readings applicable to the billing period.

Field 12– Night kWh Consumption (23.00 – 08.00)

The night rate energy consumption, if applicable, recorded in kWh that was determined for the current billing /invoicing of the MPRN provided in the line item charge. For Non-Interval MPRNs, this would be determined by the system by deducting the last meter reading that was subject to a billing / invoicing process from the current scheduled meter reading or any reading provided to facilitate termination of any contract. Multipliers are applied where applicable. Where multiple day / night registers are encountered at any MPRN, the total night consumption is determined by aggregating the derived consumption determined for each night register for the billing period. For QH MPRNs the night consumption for the period is determined based on all the 15-minute profile meter readings applicable to the billing period.

Field 14– 24 Hr kWh Consumption

The 24hr energy consumption, if applicable, in kWh that was determined for the current billing /invoicing period of the MPRN provided in the line item charge. For Non-Interval MPRNs, this would be determined by the system by deducting the last meter reading that was subject to a billing / invoicing process from the current scheduled meter reading or any reading provided to facilitate termination of any contract. Multipliers are applied where applicable. Where multiple 24hr registers are encountered at any MPRN, the total 24hr kWh consumption is determined by aggregating the derived consumption determined for each 24hr register for the billing period.

Field 23 -28 Standard Smart Tariff:

Smart tariffs charge different rates during different times of the day, with a typical smart meter tariff having three rates: a day rate, a night rate and a peak rate. This time-of-use pricing, allows you to take advantage of lower rates during off-peak hours.

Field	Description	Start	End
23	Day Off Peak Kwh	08:00:00	16:59:00
		19:00:00	22:59:00
25	Night Off Peak Kwh	00:00:00	07:59:00
		23:00:00	23:59:00
27	Peak Kwh	17:00:00	18:59:00

Where a Smart Meter has been installed, the Supplier can request, with the customer's consent Interval or Non-Interval Smart Data Services. Energy consumption for Non-Interval services (MCC16) will use three Standard Smart

Tariff (SST) registers Day Off Peak, Night Off Peak and Peak to determine the periodic consumption at this site.

Energy consumption for Interval sites (Half Hourly)(MCC12) will be consolidated into the Standard Smart Tariff register timeslots similar to Non Interval Sites.

5.7 Billing / Invoicing Reversals

Billing / invoicing reversals are a necessary feature of billing and invoicing processing and are triggered by:

- Receipt of actual meter reading with a lower value than an estimated meter reading to which a billing, invoicing or aggregated invoicing has been generated
- Receipt and validation of an actual reading that is lower than previously recorded actual readings (assumes no clock-over) to which a billing, invoicing or aggregated invoicing has been generated.
- System entry of incorrect scheduled or non-scheduled meter readings/consumptions
- Delayed processing of meter related meter works where the effective date for installation or removal pre-dates other readings to which a billing, invoicing or aggregated invoicing has been generated.
- Incorrectly operated registrations including change of supplier, change of legal entity and change of DUoS Group.

The consequences of these triggers include:

- Reversal of all intervening billing and invoicing documents at the MPRN level.
- Correction of all affected meter readings
- Issue of meter reading withdrawal and replacement messages to suppliers
- Production of replacement billing and invoicing documents
- Adjustment lines on next Supplier Invoice. Separate lines will be included in the *MPRN Level Invoice Item Detail* for each reversal and each rebilling event applicable to any meter point.

The replacement billing / invoicing line will only be included in the *MPRN Level Invoice Item Detail* where the original billing / invoicing event and any subsequent reversal and/or replacement takes place within the currency open aggregated invoicing period.

5.8 Treatment of VAT

VAT is applied as normal on Supplier Invoices/Credit Notes.

VAT is also calculated at the MPRN level during the nightly batch invoice processing of MPRN billing documents in SAP IS-U. Output from this invoice processing is displayed in the *MPRN Level Invoice Item Detail* flat file, field 28 of which reflects the total net charge (exclusive of VAT) and field 29 which reflects the gross charge (inclusive of VAT) that is applicable to each invoice item. This gross amount is provided to facilitate the Supplier when raising designated disputes i.e. the Supplier withholds payment of the gross amount of an invoice item pending resolution of a designated dispute.

Minor rounding differences can be anticipated between the total of the Gross Amount fields included *MPRN Level Invoice Item Detail* and the gross amount as shown on the Supplier Invoice/Credit Note which produced as part of the aggregated invoicing process in SAP IS-U.

6. Business Scenarios & MPRN Level Invoice Item Detail Documentation

6.1 General

This section considers a range of typical business scenarios that will feature in the open electricity market and demonstrates their impact on the *MPRN Level Invoice Item Detail* documentation following meter reading, billing, invoicing and aggregated invoicing processing. Reading estimates and money values used in the scenarios are for illustrative purposes only.

The following scenarios are addressed

- Receipt of actual meter reading with values lower than previous estimated readings
- Customer own reading processing
- Change of Supplier process
- Change of Legal Entity process
- Change of DUoS Group Process
- Change of Maximum Import Capacity (MIC) process
- Delayed processing of meter exchange
- De-energisation
- Tariff Adjustments
- Meter reading with Smart Data Services
- Change from MCC01 to MCC16

6.2 Receipt of actual meter reading with values lower than previous estimated readings

Scenario

Following issue of scheduled meter reading order to meter reader, an actual meter reading result is received in SAP IS-U that is lower than two previously estimated scheduled readings. The actual meter reading is deemed plausible and the billing order status is updated to 'billable'. The overestimates are re-estimated by interpolation of the actual readings.

See Figure 6.2 for detailed presentation of this scenario

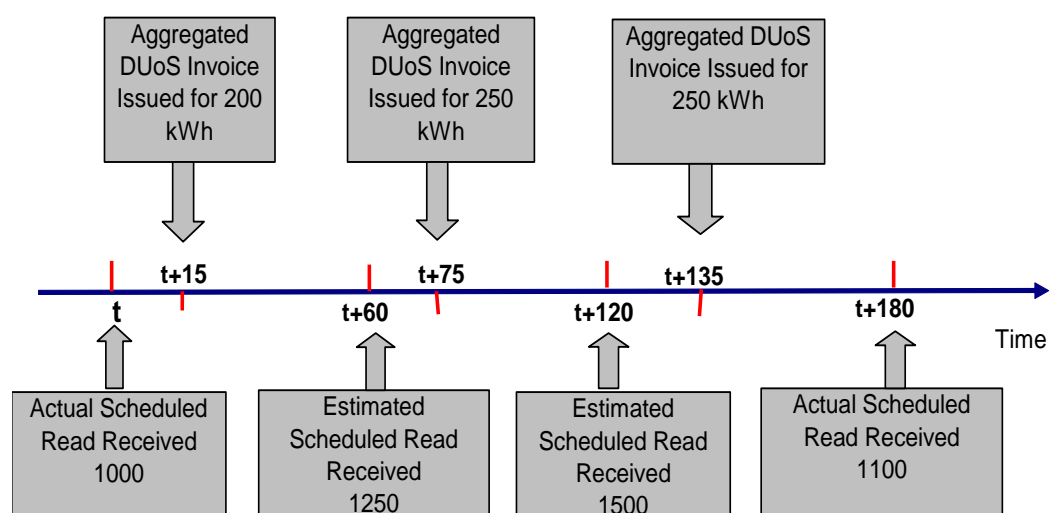

Figure 6.2 Present Less than Previous

Consequences

- Reversal of all billing and invoicing documents in respect of the MPRN line item on DUoS Supplier Invoices for (t + 75) and (t + 135).
- Withdrawal of affected meter readings received and processed at (t + 60) and (t + 120) – Market Message 300W
- Re-estimation of affected meter readings for (t + 60) and (t + 120) – Market Message 305
- Production of replacement billing and invoicing documents for affected readings
- Generation of adjustment lines on *MPRN Level Invoice Item Detail* for next Supplier Invoice

The *MPRN Level Invoice Item Detail* supporting the next aggregated Supplier Invoice at (t + 195) is portrayed as follows (relevant details only included):

Invoice No	Item No	Adjustment Reference	Billing Date From	Billing Date To	24hr kWh Consumption	24h Energy Charge	Standing Charge	Net Amount	Key to Invoice Line Item
9	1074527	1032289	t + 61	t + 120	-250	-6.98	-6.73	-13.71	Full Reversal of supplier invoicing at (t + 135)
9	1074528		t + 61	t + 120	35	0.98	6.73	7.71	Re-invoicing of re-estimation for period (t + 61) to (t +120)
9	1074529	993672	t	t + 60	-250	-6.98	-6.73	-13.71	Full Reversal of supplier invoicing at (t + 75)
9	1074530		T	t + 60	35	0.98	6.73	7.71	Re-invoicing of re-estimation for period (t) to (t +60)
9	1074531		t + 121	t + 180	30	0.84	6.73	7.57	New charge for period (t + 121) to (t +180)

6.3 Customer Own Reading Processing

Scenario

The meter reader fails to obtain access to the meter location for a MPRN for the purposes of obtaining a scheduled reading and leaves a card inviting the customer to ring the call centre with an own reading. As no reading is available at the close of the meter reading / billing period, the billing / invoicing processing is effected on the basis of a system generated estimated meter reading for the scheduled meter reading date. The resulting invoicing output is included in the next aggregated supplier invoicing. The customer rings the call centre 15 days later and provides a current own reading. This reading which is less than the last estimate in respect of a scheduled reading is deemed plausible.

See Figure 6.3 for detailed representation of this scenario

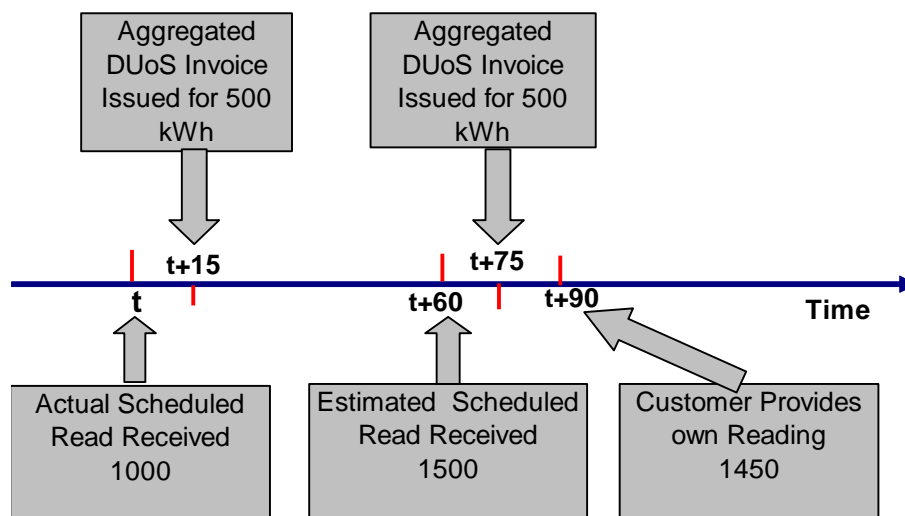

Figure 6.3 Customer Own Read

Consequences

- Reversal of billing and invoicing document in respect of the MPRN Level Invoice Item on DUoS Supplier Invoice for (t + 75) for affected reading at (t + 60)
- Withdrawal of affected meter reading (t + 60) – Market Message 300W
- Re-estimation of affected meter readings (t + 60) resulting in an estimated reading of 1270
- Production of replacement billing and invoicing documents for the affected reading (t + 60)
- Market Message 305 issues to communicate replacement estimated reading at (t + 60)
- Billing processing for CoR at (t + 90)
- Market Message 300 to registered supplier confirming plausible customer own read of 1450 at (t + 90)
- Generation of adjustment lines on MPRN Level Invoice Item Detail for next Supplier Invoice
- No DUoS billing is effected for customer own reading (t + 90). This is automatically subsumed by next scheduled meter reading / billing.

The *MPRN Level Invoice Item Detail* supporting the next Supplier Invoice is portrayed as follows (relevant details only included):

Invoice No	Item No	Adjustment Reference	Billing Date From	Billing Date To	24hr kWh Consumption	24h Energy Charge	Standing Charge	Net Amount	Key Invoice Item to Line Item
7	1014532	995342	t	t + 60	-500	-13.96	-6.73	-20.69	Full Reversal of invoicing at (t+75)
7	1014533		t	t+ 60	270	7.54	6.73	14.27	Re-invoicing of consumption re-estimation of 270 for period t to (t+60)

The 'Key to Invoice Line Item' column is not included in the *MPRN Level Invoice Item Detail*. It is included here to facilitate reader understanding through provision of the reason for the invoice line item. Actual dates will of course be reflected (YYYYMMDD) in the *MPRN Level Invoice Item Detail*. This illustration is for an urban customer (DG1)

6.4 Change of Supplier Process

Scenario

Supplier SXX requests change of supplier process in respect of customer for a MPRN and provides a required date with customer own reading. MRSO operate the change of supplier for the supplied reading which is deemed plausible and process the registration of change of supplier from supplier SYY to SXX for the required date. Final billing of the MPRN in respect of Supplier SYY is affected. Initial billing / invoicing in respect of Supplier SXX is affected at next scheduled meter reading / billing of the MPRN.

See Figure 6.4 for detailed representation of this scenario

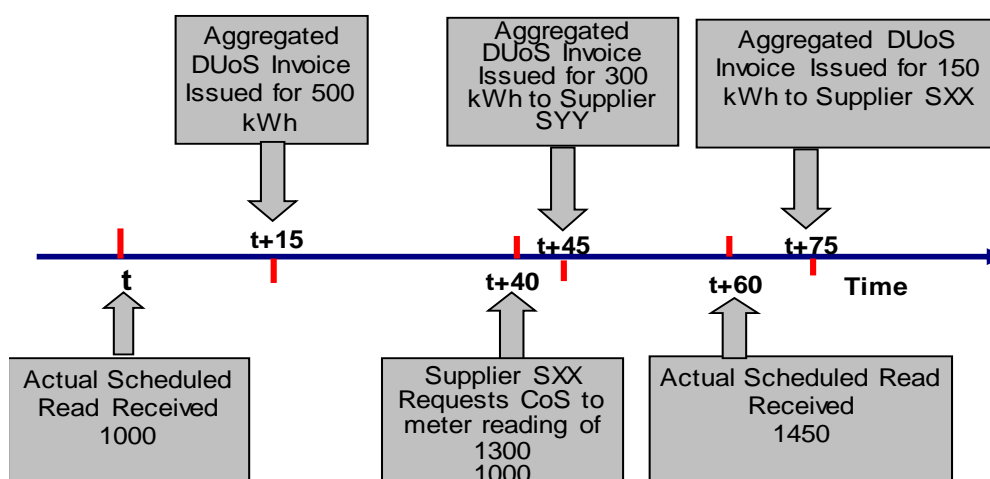

Figure 6.4 Change of Supplier

Consequences

- Market Message 010 received from Supplier SXX advising CoS details including provided reading of 1300
- CoS processed by MRSO, the provided reading is deemed plausible and Market Message 310 issues to Supplier SYY with closing reading included.
- Market Message 320 issues to Supplier SXX
- Final Billing of Supplier SYY is issued for provided meter reading of 1300 for ($t + 40$).
- Final Billing is reflected in aggregated invoicing to Supplier SYY at ($t + 45$)
- Billing / invoicing documents in respect of actual reading of 1450 processed for next scheduled meter reading for the MPRN
- Market Message 300 issues for scheduled reading of 1450 at ($t + 60$)
- Supplier Invoice issues to Supplier SXX at ($t + 75$) for initial billing period ($t + 41$) to ($t + 60$).

The *MPRN Level Invoice Item Detail* supporting the Supplier Invoice to Supplier SYY at ($t + 45$) is portrayed as follows (relevant details only included):

Invoice No	Item No	Adjustment Reference	Billing Date From	Billing Date To	24hr kWh Consumption	24h Energy Charge	Standing Charge	Net Amount	Key to Invoice Line Item
3	974128		t	t+ 40	300	8.38	4.48	12.86	Final Billing to Supplier SYY at (t + 45) for period (t) to (t + 40)

The *MPRN Level Invoice Item Detail* supporting the Supplier Invoice to Supplier SXX at (t + 75) in respect of next scheduled reading covering initial billing / invoicing period (t + 41) to (t + 60) is portrayed as follows (relevant details only included):

Invoice No	Item No	Adjustment Reference	Billing Date From	Billing Date To	24hr kWh Consumption	24h Energy Charge	Standing Charge	Net Amount	Key to Invoice Line Item
5	994582		t + 41	t+ 60	150	4.19	2.24	6.43	Initial Billing to Supplier SXX at (t + 75) for period (t+41) to (t + 60)

The 'Key to Invoice Line Item' column is not included in the *MPRN Level Invoice Item Detail*. It is included here to facilitate reader understanding through provision of the reason for the invoice line item. Actual dates will of course be reflected (YYYYMMDD) in the *MPRN Level Invoice Item Detail*. This illustration is for an urban customer (DG1)

6.5 Change of Legal Entity (CoLE) Process

Scenario

The registered Supplier advises ESB Networks of change of legal entity details in respect of the registered customer for a MPRN (<30kVA). Supplier provides a required date including read for this event. ESB Networks establishes that scheduled billing has occurred between the supplier required date and date of notification of the CoLE. In accordance with the agreed rules as determined for the mass market (<30kVA), ESB Networks determine the effective date as the message received date and generate an estimate read for this date. The CoLE is processed.

See Figure 6.5 for detailed representation of this scenario.

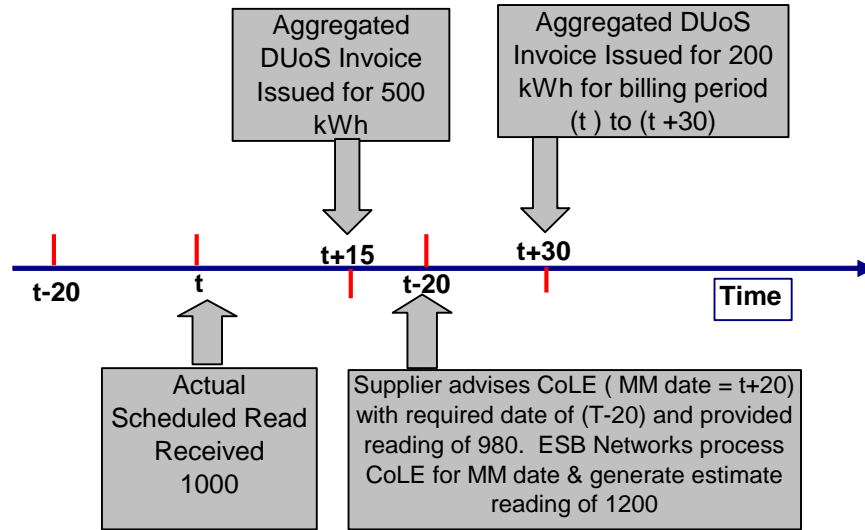

Consequences

- Market Message 016 advising CoLE details in respect of the registered customer at the cited MPRN. A required date including reading is provided.
- In accordance with the agreed market rules, the CoLE for the required date will not be processed as it pre-dates the last scheduled billing / invoicing. The CoLE is processed to a system-generated estimate for the Market Message date. Market Message 116 confirms completion of the CoLE for the message received date (t + 20) with a system-generated reading estimate of 1200
- Market Message 300 issues to supplier communicating the system-generated estimated reading that supported the final billing to supplier in respect of the 'old' legal entity.
- Final Billing of terminated 'contract' for 'old' legal entity for system-generated estimated reading of 1200 for (t + 20).
- This Final Billing is reflected on aggregated invoicing to Supplier at (t + 30)
- Billing / invoicing for period (t + 21) to date of provision of next scheduled plausible meter reading is included in subsequent aggregated invoicing.

The *MPRN Level Invoice Item Detail* in respect of the final billing of the 'old' legal entity supporting the Supplier Invoice to Supplier at (t + 30) is portrayed as follows (relevant details only included):

Invoice No	Item No	Adjustment Reference	Billing Date From	Billing Date To	24hr kWh Consumption	24h Energy Charge	Standing Charge	Net Amount	Key Invoice Line Item
2	962937		t	t+ 20	200	5.58	2.24	7.82	Final Billing to Supplier at (t + 30) for period (t) to (t + 20)

The initial billing / invoicing for the 'new' legal entity at this MPRN for the period (t +31) to date of next scheduled meter reading. We will assume that this occurred at (t + 60) with a

plausible reading of 1590. This would be reflected in the next Supplier Invoice to Supplier at (t + 75) as follows:

Invoice No	Item No	Adjustment Reference	Billing Date From	Billing Date To	24hr kWh Consumption	24h Energy Charge	Standing Charge	Net Amount	Key to Invoice Line Item
5	993897		t + 21	t+ 60	390	10.89	4.48	15.37	Initial Billing to Supplier at (t + 75) for 'new' legal entity for period (t + 21) to (t + 60)

The 'Key to Invoice Line Item' columns are not included in the *MPRN Level Invoice Item Detail*. It is included here to facilitate reader understanding through provision of the reason for the invoice line items. Actual dates will of course be reflected (YYYYMMDD) in the *MPRN Level Invoice Item Detail*. This illustration is for an urban customer (DG1)

6.6 Change of DUoS Group Process

Scenario 1

ESB Networks allocated DG5 (<30kVA) to a MPRN reflecting change of use from residential to business residential. As DUoS Group changes within this grouping are permitted without a new connection agreement, no 'contract' termination is necessary. ESB Networks process the change with an effective date of the 1st day of the current billing period in accordance with the agreed rules. (See Proposals for New DUoS Billing System – CER Approved February 2004). A 24hr meter is installed at this site.

See Figure 6.6A for detailed representation of this scenario

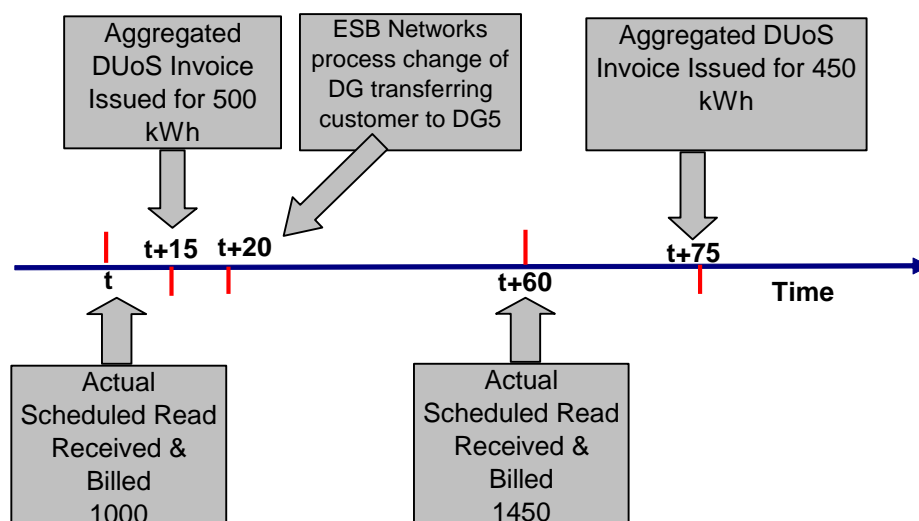

Figure 6.6A Change of DUoS Group Process

Consequences

- DG5 24hr standing charge applies for the total billing period (t) to (t + 60) for this MPRN
- DG5 24hr energy consumption charge will additionally apply for the total billing / invoicing period (t) to (t + 60) for this MPRN
- Market message 114 issues to supplier confirming change of customer details (MPD 24)
- The resulting higher charges is reflected on the Supplier Invoice to supplier at (t + 75)

The *MPRN Level Invoice Item Detail* supporting the Supplier Invoice to supplier at (t + 75) is portrayed as follows (relevant details only included):

Invoice No	Item No	Adjustment Reference	DUoS Group	Billing From Date	Billing To Date	24hr kWh Consumption	24h Energy Charge	Standing Charge	Net Amount	Key Invoice Line Item
5	993837		DG5	t	t+ 60	450	15.59	11.99	27.58	Increased energy and standing charges apply to the total billing period (t) to (t + 60) and are reflected in Supplier Invoice at (t + 75)

Scenario 2

The registered customer at a DG5 MPRN negotiates a new connection agreement with ESB Networks which increases the maximum installed capacity from 45kVa to 60kVa for the site. This necessitates a meter exchange and the installation of MD metering. DUoS Group tariff DG6 is allocated to the MPRN. Non-Interval processing continues to apply. ESB Networks process this change in SAP IS-U.

See Figure 6.6B for detailed representation of this scenario

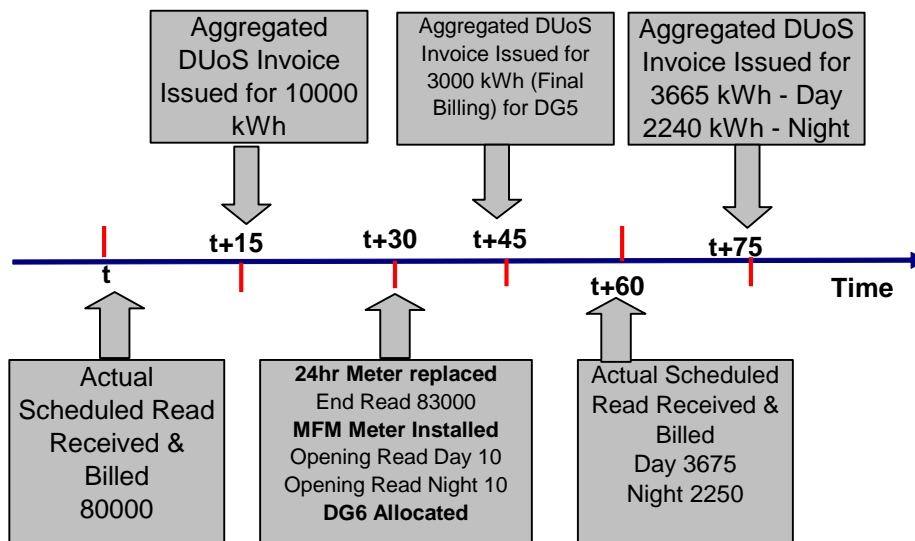

Figure 6.6B Change of DUoS Group Process

Consequences

- Final Readings for removed 24kWh meter communicated to supplier via Market Message 332
- Start Readings for day/night registers of new MD MFM meter communicated to supplier via Market Message 332
- Final billing of 'old' contract at (t + 30) based on DG5 24hr energy consumption of 3,000 kWh
- Final billing included in aggregated supplier invoicing at (t + 45).
- Initial DG6 billing for the period (t + 31) to (t+60) occurs at next scheduled reading / billing i.e. (t + 60) with standing and capacity charges pro-rated.
- Market message 300 issues to supplier to communicate the scheduled readings at (t + 60)
- This initial scheduled billing will be included in Supplier Invoice at (t +75)

The *MPRN Level Invoice Item Detail* supporting the Supplier Invoice to supplier at (t + 45) is portrayed as follows (relevant details only included):

Invoice No	Item No	Adjustment Reference	DUoS Group	Billing From Date	Billing To Date	24hr kWh Consumption	24h Energy Charge	Standing Charge	Net Amount	Key to Invoice Line Item
3	975420		DG5	t	t+ 30	3000	103.95	6.00	109.95	Final billing of 'old' contract for the billing period (t) to (t + 30) and reflected in aggregated invoice to supplier at (t + 45)

The *MPRN Level Invoice Item Detail* supporting the Supplier Invoice at (t + 75) for the initial DG6 billing for the period (t + 31) to (t+60) is portrayed as follows (relevant details only included):

Invoice No	Item Number	DUoS Group	Billing From Date	Billing To Date	Day kWh Consumption	Day Energy Charge	Night kWh Consumption	Night Energy Charge	Standing Charge	Capacity Charge	Net Amount
5	994681	DG6	t + 31	t+60	3665	75.57	2250	5.4	114.94	130.8	326.71

This initial billing of the DG6 tariff reflects the new standing charge and the introduction of a capacity charge both pro-rated to take account of the number of days in the billing period.

6.7 Change of MIC (on its own) Process

Scenario

The registered customer at a DG6 Non-Interval MPRN site makes application to ESB Networks for an increase in import capacity of 10 kVA which increases the total maximum import capacity to 75 kVA. ESB Networks conclude a new connection agreement with the customer for the new capacity.

Consequences

- Market Message 301 issued to Supplier to communicate change of connection characteristics for the concerned MPRN (MPD8)

- No increase in standing charge or energy consumption charges is applicable as the same DUoS Group continues to apply.
- The increased capacity charge in respect of the new capacity will apply from the 1st day of the next billing period i.e. (t + 61)

See Figure 6.7 for detailed representation of this scenario (Demand and wattless measurements excluded)

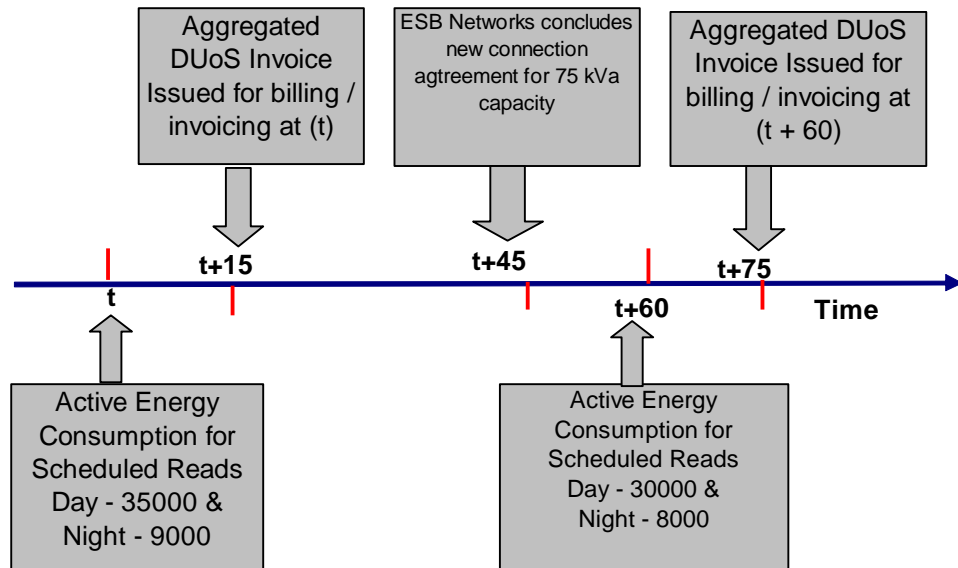

Figure 6.7 Change of MIC

The *MPRN Level Invoice Item Detail* supporting the Supplier Invoice to supplier at (t + 15) is portrayed as follows (relevant details only included):

Invoice No	Item No	Day kWh Consumption	Day Energy Charge	Night kWh Consumption	Night Energy Charge	Standing Charge	Capacity Charge	Net Amount
1	956720	35000	721.70	9000	21.60	114.94	141.70	999.94

The *MPRN Level Invoice Item Detail* supporting the Supplier Invoice to supplier at (t + 75) is portrayed as follows (relevant details only included):

Invoice No	Item No	Day kWh Consumption	Day Energy Charge	Night kWh Consumption	Night Energy Charge	Standing Charge	Capacity Charge	Net Amount
5	994678	30000	618.60	8000	19.20	114.94	163.50	916.24

6.8 Delayed Processing of Meter Exchange

Scenario

ESB Networks arrange a replacement of the 24hr meter at a referenced MPRN under a mass metering replacement programme. The Networks Technician completes the work sheet recording date of exchange, closing reading of replaced meter and opening reading of the new meter. Due to an oversight, the completed work sheet did not reach the back office responsible for SAP IS-U update until six weeks after the meter exchange. In the interim period, an estimated reading was system generated against a scheduled meter reading order as the reader had failed to get access to the meter location.

See Figure 6.8 for detailed representation of this scenario

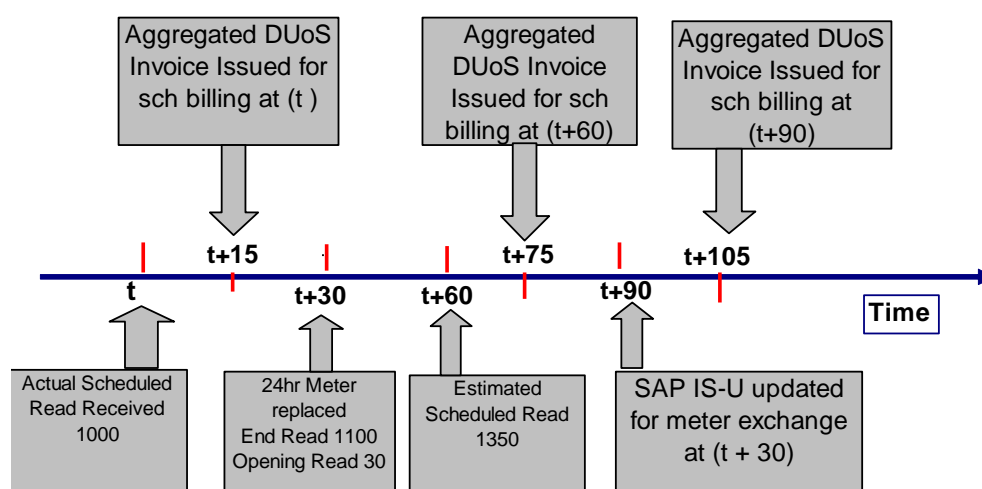

Figure 6.8 Delayed Processing of Meter Exchange

Consequences

- Reversal of billing and invoicing document in respect of the MPRN invoice line item on DUoS Supplier Invoice for (t + 75).
- Withdrawal of affected estimated meter reading (t + 60) – Market Message 300W
- Market Message 332 issues to communicate final reading of replaced meter at (t + 30) and start reading of new meter at (t + 31)
- Re-estimation of affected estimated meter readings for (t + 60), assume 1200 – Market Message 305
- Production of replacement billing and invoicing documents for affected reading at (t + 60)
- Generation of adjustment lines on MPRN Level Invoice Item Detail for next Supplier Invoice at (t + 105)

The *MPRN Level Invoice Item Detail* supporting the Supplier Invoice at (t + 75) is portrayed as follows (relevant details only included):

Invoice No	Item No	Adjustment Reference	Billing Date From	Billing Date To	24hr kWh Consumption	24h Energy Charge	Standing Charge	Net Amount	Key Invoice Item to Line
5	994689		t	t+ 60	350	9.77	6.73	16.50	Billing to Supplier at (t + 75) for billing period (t) to (t + 60)

The MPRN Level Invoice Item Detail supporting the Supplier Invoice at (t + 105) is portrayed as follows (relevant details only included):

Invoice No	Item No	Adjustment Reference	Billing Date From	Billing Date To	24hr kWh Consumption	24h Energy Charge	Standing Charge	Net Amount	Key Invoice Item to Line
7	1013467	994689	T	t + 60	-350	-9.77	-6.73	-16.50	Reversal of Billing to Supplier at (t + 75) for billing period (t) to (t + 60)
7	1013468		t	t+ 60	200	5.58	6.73	12.31	Re-billing to Supplier at (t + 105) for revised estimate for billing period (t) to (t + 60)

6.9 De-energisation

Scenario

Supplier SXX requests de-energisation for a DG1 MPRN. DSO arranges the de-energisation and returns works order to the back office SAP IS-U database update team. SAP IS-U is subsequently updated.

See Figure 6.9 for detailed representation of this scenario.

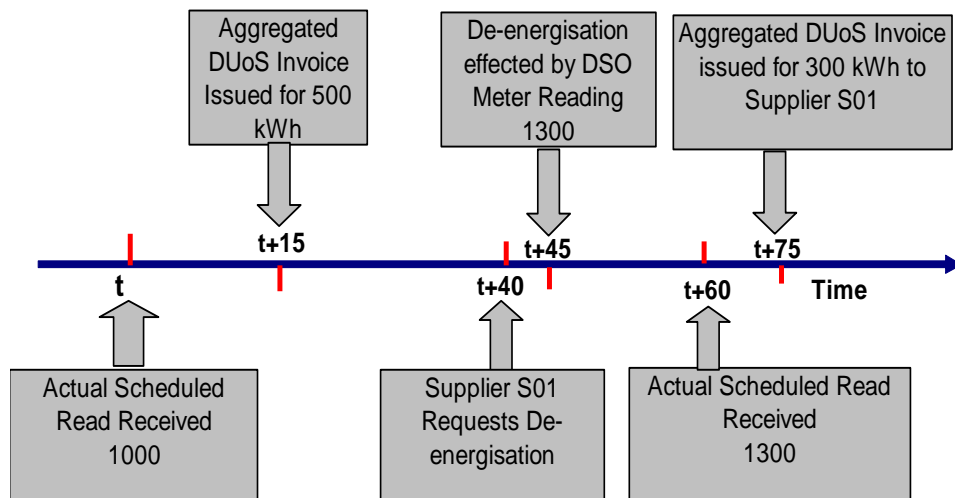

Figure 6.9 De-energisation

Consequences

- De-energisation effected by DSO at (t + 45). Market Message 306 issues to Supplier SXX confirming completion of transaction and including meter reading of 1300
- Scheduled meter reading effected at (t + 60) which confirms that reading remains at 1300. Scheduled billing / Reading also affected. Market Message 300 issues to supplier SXX
- Aggregated invoicing to supplier SXX at (t + 75) for the billing period (t) to (t + 60)

The *MPRN Level Invoice Item Detail* supporting the Supplier Invoice at (t + 75) is portrayed as follows (relevant details only included):

Invoice No	Item No	Adjustment Reference	Billing Date From	Billing Date To	24hr kWh Consumption	24h Energy Charge	Standing Charge	Net Amount	Key to Invoice Line Item
5	994697		t	t+ 60	300	8.38	6.73	15.11	Billing to Supplier at (t + 75) for billing period (t) to (t + 60)

Should this MPRN continue to be de-energised for the ensuing billing period – assume (t + 61) to (t + 120) with no advance in meter confirmed at scheduled reading at (t + 120), the *MPRN Level Invoice Item Detail* supporting the Supplier Invoice to supplier at (t + 135) would be portrayed as follows (relevant details only included):

Invoice No	Item No	Adjustment Reference	Billing Date From	Billing Date To	24hr kWh Consumption	24h Energy Charge	Standing Charge	Net Amount	Key to Invoice Line Item
7	1014975		t + 61	t+120	0	0.00	6.73	6.73	Billing to Supplier at (t + 135) for billing period (t + 61) to (t + 120)

6.10 Tariff Price Changes

Scenario

CRU approve a revised schedule of DUoS charges which take effect from the 1st October. Demonstrate the impact of this in terms of the MPRN Level Invoice Item Detail that will be forwarded to suppliers. Assume a 5% increase in both standing and energy consumption charges. We will use a DG1 MPRN with a 24hr meter to demonstrate this scenario

See Figure 6.10 for detailed representation of this scenario

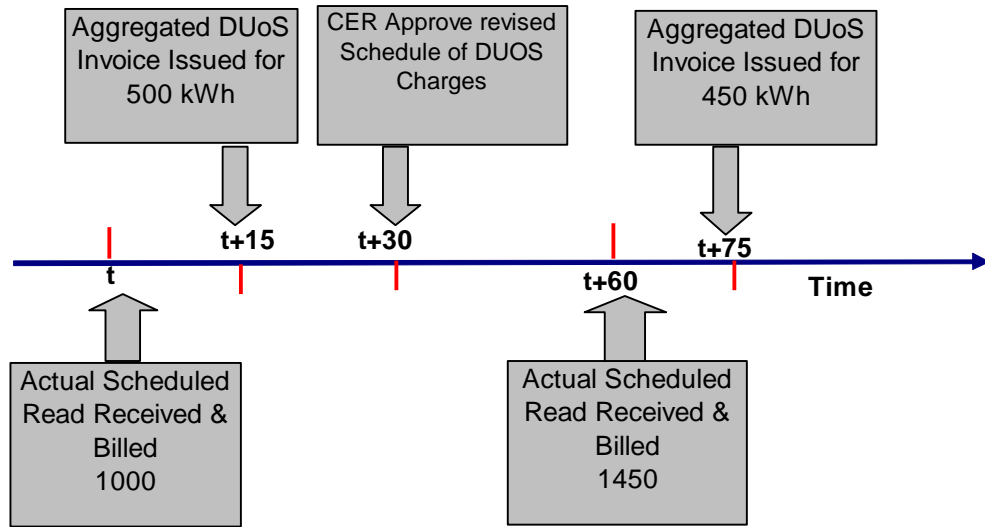

Figure 6.10 Tariff Price Changes

Consequences

- Price increase at (t + 30) necessitates time slicing of standing and energy consumption charges for scheduled billing at (t + 60). Let us assume that the system estimates energy consumption of 250 kWh for period (t) to (t+30) and 200 kWh for period (t + 31) to (t + 60). The standard estimation algorithm is used for this purpose.
- Will result in one invoice line on the Supplier Invoice at (t + 75) reflecting this time slicing

The *MPRN Level Invoice Item Detail* supporting the Supplier Invoice at (t + 75) will be portrayed as follows (relevant details only included):

Invoice No	Item No	Adjustment Reference	Billing Date From	Billing Date To	24hr kWh Consumption	24h Energy Charge	Standing Charge	Net Amount	Key to Invoice Line Item
5	994648		t	t+ 60	450	12.84	6.89	19.73	Billing to Supplier at (t + 75) for billing period (t) to (t + 60). Energy charge is calculated by applying old price to 250 kWh and new price to 200 kWh. Standing charges are applied through time slicing the billing period.

The 'Key to Invoice Line Item' column is not included in the *MPRN Level Invoice Item Detail*. It is included here to facilitate reader understanding through provision of the reason for the invoice line item. Actual dates will of course be reflected (YYYYMMDD) in the *MPRN Level Invoice Item Detail*.

6.11 Meter Reading with Smart Data Services

Scenario

Where the Comms Technically Feasible (CTF) value is changing from 01 to 02 / 03 / 04, the device will be updated as remotely read and the MPRN will be moved to a remotely read Meter Reading Unit (MRU).

Where the CTF value has changed from 04 / 03 / 02 to 01, the device will be updated as manually read and the MPRN will be moved to a manually read MRU.

In this example a DG5 Customer who has Non-Interval Smart Data Services (MCC16) has been manually read but the CTF has improved to 02. This MPRN is automatically moved to a remotely read MRU on the 1st of August. The MPRN Level Invoice Item Detail supporting the invoice will be portrayed as follows (relevant details only included);

Figure 6.11 MPRN Level Invoice Item Detail with change in CTF

Header	Inv No	Inv Item No	MPRN	Adj Ref No	Inv Type	DUoS Group	Bill From	Bill To	Standing Charge	Day Off Peak KWH	Day Off Peak Charge	Night Off Peak KWH	Night Off Peak Charge	Peak KWH	Peak Charge	Net	Gross
1	2	3	4	5	6	7	8	9	16	23	24	25	26	27	28	29	30
1	70100009999	DSO	SXX														
2	70100009999	#####	XXXXXXXXXX		1S	DG5	20190710	20190906	15.2	3065	155.95	532	3.31	250	12.72	187.22	212.49

The MPRN Level Invoice Item Detail reflects the MPRN through the complete billing period without reference to any changes in the meter reading source (i.e. Manually read or Remotely read).

6.12 Change from MCC01 to MCC16

Scenario

A DG1 customer requests a change from MCC01 to the new Smart MCC16. The installation is reconfigured from MCC01 to MCC16 on the 30th of November 2019. The Supplier is DUoS billed for this MPRN from the 7th November 2019 to the 30th November 2019 which spans a period where it was MCC01 and then billed as reconfigured to the new SMART MCC16 from the 1st of December 2019 until the 9th of March 2020. The MPRN Level Invoice Item Detail supporting the Supplier invoice displayed as follows in Figure 6.12.1-3 to illustrate the exchange. In practice this MPRN will display as one line on the MPRN Level Invoice Item Detail.

seg_id	opbel	ref_no	mprn(11)	adjus t_ref	bill_c ode	duos _grp	bill_from(8)	bill_to(8)	day_kwh	day_charge
1	70100009999	DSO	SXX							
2	70100009999	605006605264000000	11111111111		1S	DG1	20191107	20191130	282	11.22
2	70100009999	605006605479000000	11111111111		1S	DG1	20191201	20200309	0	0
3		2	46.31							

Figure 6.12.1 MPRN Level Invoice Item Detail (1 of 3)

night_kwh	night_chARGE	tfhr_kwh	tfhr_chARGE	stnd_chARGE	capc_chARGE	mic_a	max_kv	mic_surc_hARGE	react_kv_a	lpf_surcharge	dayop_kwh
0	0			4.38	0	0	0	0	0		
0	0			17.77	0	0	0	0	0		200

Figure 6.12.2 MPRN Level Invoice Item Detail (2 of 3)

dayop_charge	nightop_kwh	nightop_charge	peak_kwh	peak_charge	charge_sum	betrw
					15.6	15.6
9.62	150	0.92	50	2.4	30.71	30.71

Figure 6.12.3 MPRN Level Invoice Item Detail (3 of 3)

7. Field Descriptions of *MPRN Level Invoice Item Detail* Documentation

7.1 General

The *MPRN Level Invoice Item Detail* is produced as part of the twice monthly supplier invoicing process and provides detail of all charges applied at individual MPRN level.

A sample printout of this document is included in Appendix 1. This document has been specially formatted with field headings to facilitate detailed portrayal of the data contained therein. The actual file forwarded to suppliers via SFTS / EE is a flat file format, with data definitions and formats specified in the document titled *DUoS, Transaction and PSO Payment Process – MOIP April 2004*

The following is a description of the information contained in each field including its derivation:

7.2 Header Fields

Header information is provided for each flat file forwarded to suppliers

Field 1 – Segment ID

This is an identifier to categorise the level in the file e.g. 1 = Header record (1 record only)

Field 2 – Invoice Number

This is the unique number that references the Supplier Invoice/Credit Note information being provided

Field 3 – Sender ID

This is the unique identifier of the Market Participant sending the flat file. For ESB Networks, this is DSO (Distribution System Operator).

Field 4 – Supplier ID

This is the unique identifier of the Market Participant receiving the flat file. This will correspond with the Supplier ID for the Supplier registered on the MPRN.

Field 5 – Time Stamp

This is a time and date stamp indicating the time and date that the file was created. This is defined as:

- YYYYMMDDHHMMSS

7.3 Item Detail Fields

Field 1 – Item Number

This is an identifier to categorise the level in the file e.g. 2 = Item Detail Record (1..n records)

Field 2 – Invoice Number

This is the unique identifier of the Supplier Invoice/Credit Note to which the item relates.

Field 3 – Invoice Item Number

This is a unique reference to a line Item on a file. This number is used to reference which item is being disputed in a 507 message.

Field 4 – MPRN

This is the unique identifying reference number for the Meter Point. All elements of the MPRN will be provided.

Field 5 – Adjustment Reference Number

This is only displayed where a billing/invoicing reversal is being made for an invoice item included in a previous Supplier Invoice. The adjustment reference is the Invoice Item Number of the original invoice item.

Field 6 – Invoice Type

Unique system identifier to identify the type of invoice item. The following types have been provided:

- 1S New Charge – Sequential Bill e.g. Scheduled or final billing / invoicing of any MPRN
- 2S Adjustment Credit – Reversal of Sequential Bill. Full reversal of any scheduled or final billing / invoicing of any MPRN
- 3S Adjustment Debit – Re-billing / invoicing of any sequential bill
- 2C Adjustment Credit – Manual billing credit
- 2D Adjustment Credit – Reversal of manual billing debit
- 3C Adjustment Debit – Reversal of manual billing credit
- 3D Adjustment Debit – manual billing debit

Field 7 – DUoS Group

DUoS Group tariff applicable to the MPRN provided in the invoice item

Field 8 – Billing Date From

The date from which the billing period for the invoice item became effective.

Field 9 – Billing Date To

The date to which the billing period for the invoice item was effective

Field 10 – Day kWh Consumption (08.00 – 23.00)

The Day rate energy consumption, if applicable, recorded in kWh that was determined for the current billing /invoicing period of the MPRN provided in the invoice item charge. For Non-Interval MPRNs, this would be determined by the system by deducting the last meter reading that was subject to a billing / invoicing process from the current scheduled meter reading or any reading provided to facilitate termination of any contract. Multipliers are applied where applicable. Where multiple day/night registers are encountered at any MPRN, the total day consumption is determined by aggregating the derived consumption determined for each day register for the billing period. For QH MPRNs the day consumption for the period is determined based on all the 15-minute profile meter readings applicable to the billing period.

Field 11 – Day Energy Charge

Total day kWh consumption as determined in Field 10 multiplied by the associated DUoS tariff rate applicable for the billing period for the MPRN. Proration will apply where different tariff rates are applicable for the billing period.

Field 12 – Night kWh Consumption (23.00 – 08.00)

The night rate energy consumption, if applicable, recorded in kWh that was determined for the current billing /invoicing of the MPRN provided in the invoice item charge. For Non-Interval MPRNs, this would be determined by the system by deducting the last meter reading that was subject to a billing / invoicing process from the current scheduled meter reading or any reading provided to facilitate termination of any contract. Multipliers are applied where applicable. Where multiple day / night registers are encountered at any

MPRN, the total night consumption is determined by aggregating the derived consumption determined for each night register for the billing period. For QH MPRNs the night consumption for the period is determined based on all the 15-minute profile meter readings applicable to the billing period.

Field 13 – Night Energy Charge

Total night kWh consumption as determined in Field 12 multiplied by the associated DUoS tariff rate applicable for the billing period for the MPRN. Proration will apply where different tariff rates are applicable for the billing period.

Field 14 – 24 Hr kWh Consumption

The 24hr energy consumption, if applicable, in kWh that was determined for the current billing /invoicing period of the MPRN provided in the line item charge. For Non-Interval MPRNs, this would be determined by the system by deducting the last meter reading that was subject to a billing / invoicing process from the current scheduled meter reading or any reading provided to facilitate termination of any contract. Multipliers are applied where applicable. Where multiple 24hr registers are encountered at any MPRN, the total 24hr kWh consumption is determined by aggregating the derived consumption determined for each 24hr register for the billing period.

Field 15 – 24 Hr Energy Charge

Total 24hr kWh consumption as determined in Field 14 multiplied by the associated DUoS tariff rate applicable for the billing period for the MPRN. Proration will apply where different tariff rates are applicable for the billing period.

Field 16 – Standing Charge

This is the time based standing charge applicable to the MPRN for the billing period. It is the published annualised charge pro-rated to reflect the charge applicable to the number of days contained in the billing period and would be representative of the Billing Date From / Billing Date To dates of the invoice item detail (Fields 8 & 9). Where 24hr meters/registers and double tariff day/night meters / registers are installed at any Non-Interval MPRN, the standing charge applicable to the 24hr meter is used for determination of standing charge for billing / invoicing purposes. Pro-ration will apply where tariff rate changes are applicable to the billing period or in respect of any event necessitating termination of contract. Thus any standing charge for any final billing to supplier in respect of a customer loss is representative of the number of days contained in the final billing period i.e. number of days between start day of current billing period and effective date of Change of Supplier.

Field 17 – Capacity Charge

Capacity charge for an MPRN is the agreed capacity (MIC) as per the connection agreement multiplied by the tariff rate/KVA for the applicable DUoS Group as published in the DUoS schedule of Distribution Use of System Charges. It is pro-rated on the same basis as the Standing Charge (Field 16). It does not include any penalty component.

Field 18 – Maximum Import Capacity

The MIC is the Maximum Import Capacity in kVA which has been agreed by the customer in the connection agreement with the DSO.

Field 19 – *Max kVA*

This is the recorded max kVA for the MPRN for the billing / invoicing period

The calculation for QH,HH and Non-Interval installations is described in Section 3 above.

Field 20 – MIC Surcharge

This is the penalty surcharge where a customer exceeds the agreed level of MIC.

Field 21 – Reactive Energy kVArh

Reactive consumption as measured at the meter point for the billing period both QH and Non-Interval

Field 22 – Power Factor Surcharge

This is a penalty for Low Power Factor (LPF). The LPF surcharge is described in Section 5 above.

Field 23-28 Standard Smart Tariff:

Smart tariffs charge different rates during different times of the day, with a typical smart meter tariff having three rates: a day rate, a night rate and a peak rate. This time-of-use pricing, allows you to take advantage of lower rates during off-peak hours,

Field	Description	Start	End	Field	Description
23	Day Off Peak Kwh	08:00:00	16:59:00	24	Day Off Peak Charge
		19:00:00	22:59:00		
25	Night Off Peak Kwh	00:00:00	07:59:00	26	Night Off Peak Charge
		23:00:00	23:59:00		
27	Peak Kwh	17:00:00	18:59:00	28	Peak Charge

Field 29 – Net Amount

This is the total of net charges (exclusive of VAT) that are applicable to each invoice item in respect of each MPRN.

Field 30 – Gross Amount

This is the gross amount, inclusive of VAT, in respect of all charges applicable to each invoice item in respect of each MPRN. The VAT amount is calculated during the Invoicing in SAP IS-U process as outlined in paragraph 5.8 of this document

Minor rounding differences can be anticipated between the total of the Gross Amount fields included in the invoice detail and the gross amount shown on the Supplier Invoice/Credit Note produced as part of the aggregated invoicing process in SAP IS-U. This gross amount is provided to facilitate the Supplier when raising designated disputes i.e. the Supplier withholds payment of the gross amount of an invoice item pending resolution of a designated dispute.

7.4 Footer Fields

These fields denote the end of the particular flat file provided and provides control information on the number of records and total amounts:

Field 1 – Segment ID

This is an identifier to categorise the level in the file e.g. 3 = Footer record (1 record only)

Field 2 – Total Records

This is the total number of line items in the file i.e. excluding the header and footer lines. This should equal the total number of records shown in the Summary by DUoS Group Report.

Field 3 – Control Total

This is a summation of all Net Amount charges shown on the detailed line items of the file. This should equal the total amount shown in the Summary by DUoS Group Report.

8. Appendix 1 - MPRN Level Invoice Item Detail

Header	Inv No	Inv Item No	MPRN	Adj Ref No	Inv Type	Duos Group	Bill From	Bill To	Day KWh	Day Charge	Night KWh	Night Charge	24hr KWh	24hr Charge	Standing Charge	
1	70100009999	DSO	SAA													
2	70100009999	635004456939000000	10000572618		15	DG5	20190710	20190906								15.24
2	70100009999	605006468452000000	10009250618		15	DG1	20190711	20190911								11.31
2	70100009999	630006145519000000	10003460375		15	DG5	20190710	20190904								14.72
2	70100009999	613005891818000000	10003461303		15	DG5	20190711	20190905								14.72
2	70100009999	611006054735000000	10004746098		15	DG1	20190706	20190905								11.13
2	70100009999	620006277771000000	10006507090		15	DG1	20190716	20190910								10.23
2	70100009999	602006015886000000	10014282456		15	DG2	20190731	20190902								8.9
2	70100009999	615006396709000000	10014501269		15	DG1	20190706	20190906								11.31
2	70100009999	608006374719000000	10015154063		15	DG1	20190710	20190906								10.59
2	70100009999	624005721125000000	10015240981		15	DG5	20190702	20190903								16.53
2	70100009999	622005909490000000	10302125099		15	DG1	20190707	20190902					255	9.99		10.41
2	70100009999	622005909492000000	10302125123		15	DG1	20190707	20190902					837	13.2		10.41
2	70100009999	622005909493000000	10302125130		15	DG1	20190707	20190902					259	10.15		10.41
3	13	1126.15														

Fig 8.1 MPRN Level Invoice Item (1 of 2)

Capacity Charge	MIC	Max KVA	MIC Surcharge	KVArh	LPF Surcharge	Day Off Peak KWh	Day Off Peak Charge	Night Off Peak KWh	Night Off Peak Charge	Peak KWh	Peak Charge	Net	Gross
						3065	155.95	532	3.31	250	12.72	187.22	212.49
						412	19.81	1251	7.64	50	2.40	41.16	46.72
						6149	312.86	741	4.61	450	22.90	355.09	403.02
						1280	65.13	310	1.93	200	10.18	91.96	104.37
						1945	93.54	1255	7.67	130	6.24	118.58	134.58
						183	8.8	65	0.4	12	0.59	20.02	22.72
						166	7.98	54	0.33	11	0.53	17.74	20.14
						783	37.65	269	1.64	52	2.51	59.11	60.28
						50	2.4	169	1.03	3	0.16	14.18	16.09
						2589	131.73	879	5.47	173	8.80	162.53	184.47
												20.4	23.15
												23.61	26.8
												20.56	23.34

Fig 8.2 MPRN Level Invoice Item (2 of 2)