

102P Change of Supplier Provisional Acceptance

Message

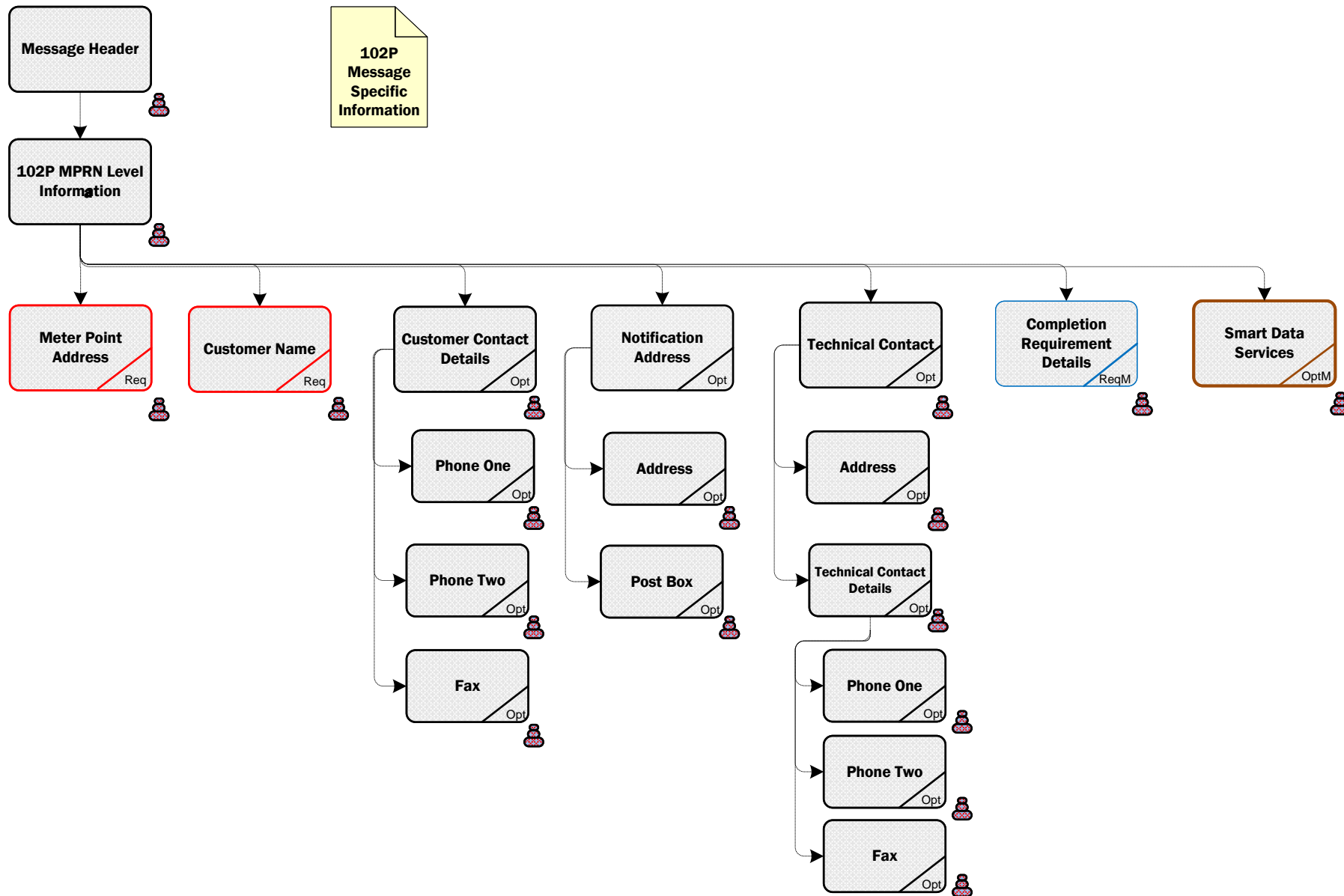

102P Change of Supplier Provisional Acceptance

102P Valid Codes

Meter Point Status

E – Meter Point is Energised only

D – Meter Point is De-Energised

Settlement Class

N – Synthetic profile to be used in settlement

P – Interval data (collected from QH Meter) to be used in settlement

U – Meter point settled using unmetered profile

Read Reason

A code that is provided only if a Special Read has been required to indicate that the Special Read is chargeable. If so, the value is set to:

02 – denoting a chargeable Special Read

Provisional Acceptance Completion Requirement Code

CAA – Connection Agreement is awaited

ENA – Energisation is Awaited

SIR – Site Visit is Required

Optional/Mandatory; Although the following Data Items are optional, note the following caveats:-

Meter Configuration Code: Provided as per registration request or as modified by MRSO

Generation Unit ID: Provided in the case of a generator site

Generation Unit Aggregation Code: Provided in the case of a generator site

Maximum Export Capacity: Provided in the case of a generator site

COS Read Arrangement: Provided as per registration request or as modified by MRSO

Meter Configuration Code: Provided as per registration request or as modified by MRSO

COS Estimate Acceptable: Provided as per registration request or as modified by MRSO

Read Reason: Provided if a special read is requested

Message

RMDS RETAIL MARKET DESIGN SERVICE

Message Specific information

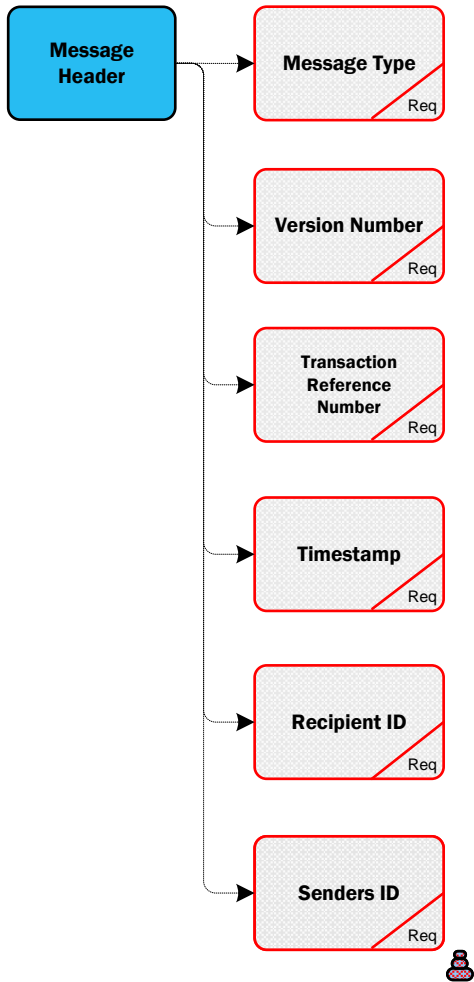

102P Change of Supplier Provisional Acceptance

Segment

| | | | | | |
|-----------------------------|---|--|---|---|--|
| 102P MPRN Level Info | MPRN Req | DUoS Group Req | Change of Tenant Legal Entity Req | Registration Receipt Date Req | Smart Non Participation Code Opt |
| | Market Participant Business Reference Req | Maximum Import Capacity Opt | Maximum Export Capacity Opt | Last Actual Read Date Opt | Comms Technically Feasible Opt |
| | Meter Point Status Req | Load Profile Opt | CoS Read Arrangement Opt | Read Frequency Opt | Smart Data Services Opt |
| | Supplier Unit ID Req | Load Factor Opt | Meter Configuration Code (Required) Opt | Read Cycle Opt | |
| | SSAC Req | Meter Configuration Code Opt | CoS Estimate Acceptable Opt | Essential Plant Flag Opt | |
| | Settlement Class Req | DLF (Distribution Loss Factor) Opt | Read Reason Opt | DUoS Billing Frequency Opt | |
| | Connection System Req | Transformer Loss Factor Opt | Required Date Opt | DUoS Billing Cycle Opt | |

Message

| | | |
|----------------------------|--|---|
| Meter Point Address | Unit No. <small>Opt</small> | Postal Code <small>Opt</small> |
| | Addr Line 1 <small>Opt</small> | City <small>Opt</small> |
| | Addr Line 2 <small>Opt</small> | County Ireland <small>Opt</small> |
| | House No. <small>Opt</small> | Country <small>Opt</small> |
| | Street <small>Opt</small> | |
| | Addr Line 4 <small>Opt</small> | |
| | Addr Line 5 <small>Opt</small> | |

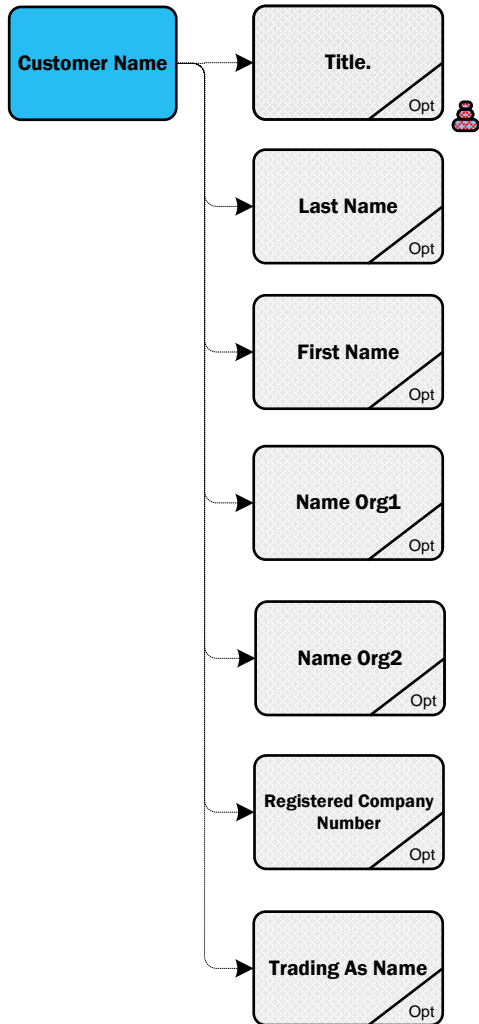

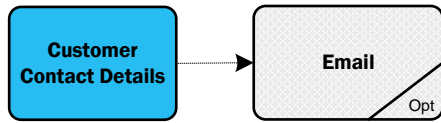

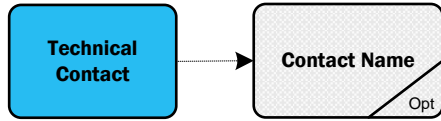

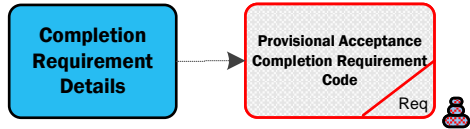

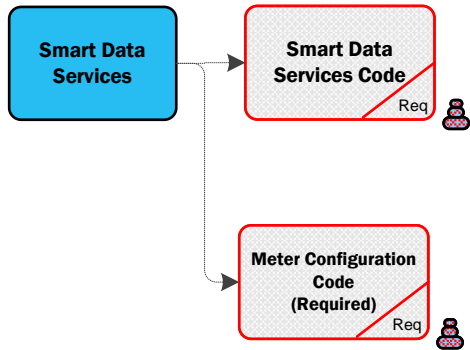

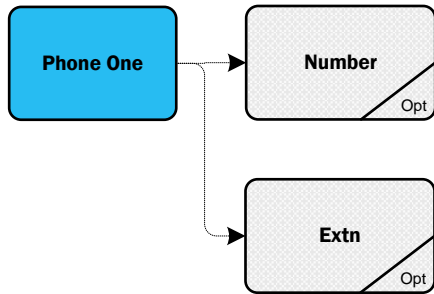

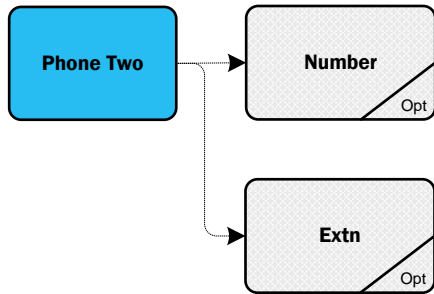

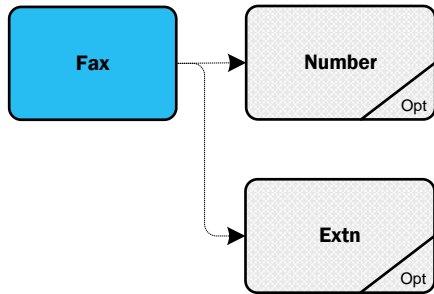

102P Change of Supplier Provisional Acceptance

Segment

Address

C/O Name
Opt

Addr Line 5
Opt

Unit No.
Opt

Postal Code
Opt

Addr Line 1
Opt

City
Opt

Addr Line 2
Opt

County Ireland
Opt

House No.
Opt

County/State
Opt

Street
Req

Country
Opt

Addr Line 4
Opt

Message

RMDS RETAIL MARKET DESIGN SERVICE

Address

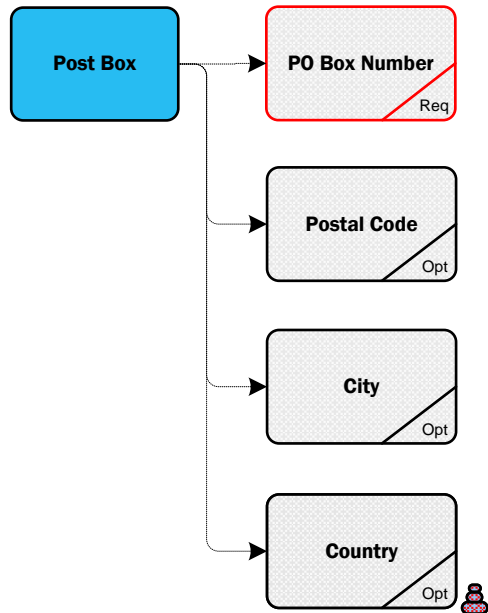

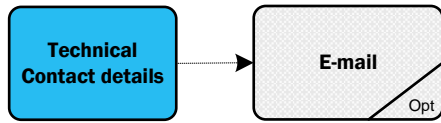

**Senders
ID**

**Click Here for Latest
Senders ID
List**

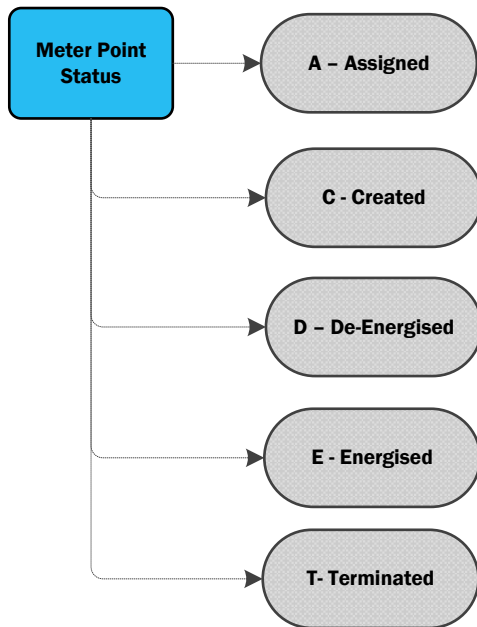

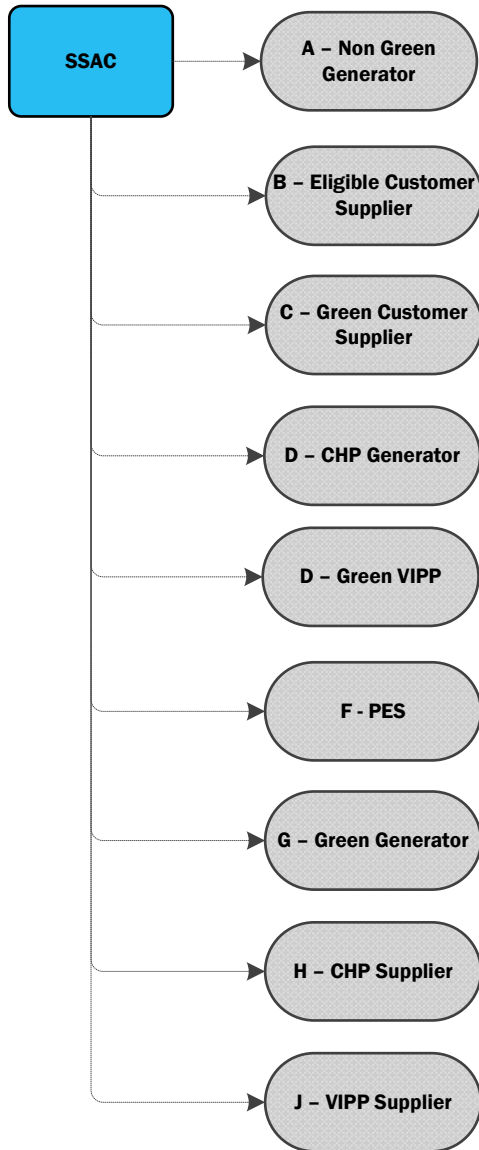

102P Change of Supplier Provisional Acceptance

Code

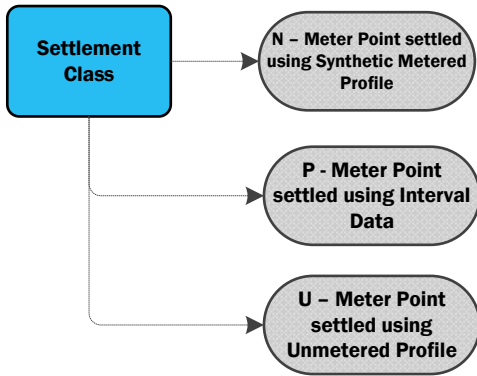

Message

MPRN Level Information

RMDS RETAIL MARKET DESIGN SERVICE

Settlement Class

102P Change of Supplier Provisional Acceptance

Code

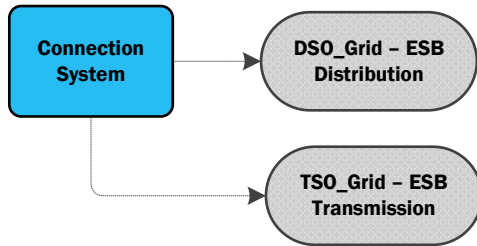

102P Change of Supplier Provisional Acceptance

Code

DUoS Group

| | | | | |
|-----|------|---|------|--|
| AGU | DG1 | Urban Domestic | DG7 | MV MD |
| AMM | DG10 | Yes | DG7A | MV MD Autoproducer |
| CAN | DG2 | Rural Domestic | DG7B | MV MD Importing Autoproducer or CHP Producer |
| CIP | DG3 | Public Lighting | DG8 | 38 kV Looped MD |
| COL | DG4 | Unmetered Supplies | DG8A | 38 kV Looped MD Autoproducer |
| COS | DG5 | LV Non-Domestic Non-MD | DG8B | 38 kV Looped MD Importing Autoproducer or CHP Producer |
| CUG | DG5A | LV Non-Domestic Non-MD Autoproducer | DG9 | 38 kV Tailed MD |
| DIJ | DG5B | LV Non-Domestic Non-MD Importing Autoproducer or CHP Producer | DG9A | 38 kV Tailed MD Autoproducer |
| DSO | DG6 | LV MD | DG9B | 38 kV Tailed MD Importing Autoproducer or CHP Producer |
| IA | DG6A | LV MD Autoproducer | DG10 | 110kV Distribution |
| ICD | DG6B | LV MD Importing Autoproducer or CHP Producer | TCON | Transmission Connected |

Message

MPRN Level Information

RMDS RETAIL MARKET DESIGN SERVICE

DUoS Group

102P Change of Supplier Provisional Acceptance

Code

Load Profile

01 - Urban Domestic Unrestricted

10 - Unmetered - Flat

02 - Urban Domestic Day/Night

11 - Public Lighting Dusk/Dawn

03 - Rural Domestic Unrestricted

12 - Public Lighting Dusk/Midnight

04 - Rural Domestic Day/Night

25 - Urban domestic SST

05 - Non Domestic Unrestricted

27 - Rural domestic SST

06 - Non Domestic Day/Night

29 - Non-domestic SST

07 - MD with LF up to (but not including) 30%

08 - MD with LF greater than or equal to 30% but less than 50%

09 - MD with LF greater than or equal to 50%

Message

MPRN Level Information

RMDS

RETAIL MARKET DESIGN SERVICE

Load Profile

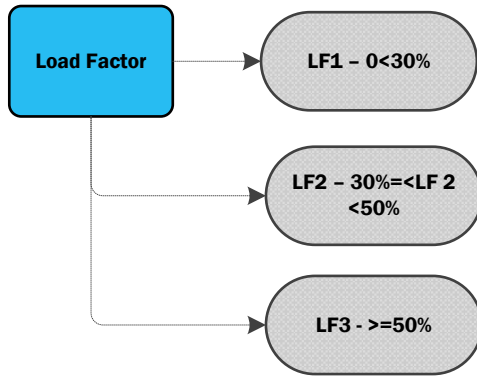

102P Change of Supplier Provisional Acceptance

Code

Meter Configuration Code(Required)

| | | | |
|-------------------|--------------------|-------------------|----------------------|
| MCC01 - 24 Hour | MCC10 - QH2CH_IP | MCC61 - 2x24h | MCC73 - 4x24H+NSH |
| MCC02 - P/N | MCC11 - QH4CH_IPXP | MCC62 - 2x24h+NSH | MCC74 - 5x24H |
| MCC03 - 24h+NSH | MCC50 - NONSTN | MCC63 - 2x24h+D | MCC75 - 24H+2xNSH |
| MCC04 - D/N+W | MCC51 - D/N+NSH | MCC64 - 2x24h+W | MCC76 - 4x24H+W |
| MCC05 - MDNm/PK | MCC53 - 2 X D/N | MCC65 - 3x24hr | MCC77 - 2x24H+W+NSH |
| MCC06 - MDNm+Pk | MCC57 - 24h+D | MCC67 - 3x24h+Day | MCC78 - 3x24H+W+NSH |
| MCC07 - 24H+NSH+W | MCC58 - 24h+D/N | MCC70 - 3x24H+NSH | MCC79 - 5x24H+NSH |
| MCC08 - 24h+W | MCC59 - 24h+D/N+W | MCC71 - 4x24H | MCC12 - HH1CH_1CR_IP |
| MCC09 - Unmetered | MCC60 - 24h+D/N+NS | MCC72 - 3x24H+W | MCC16 - SST IMP |

Message

Smart Data Services

RMDS

RETAIL MARKET DESIGN SERVICE

Meter Configuration Code (Required)

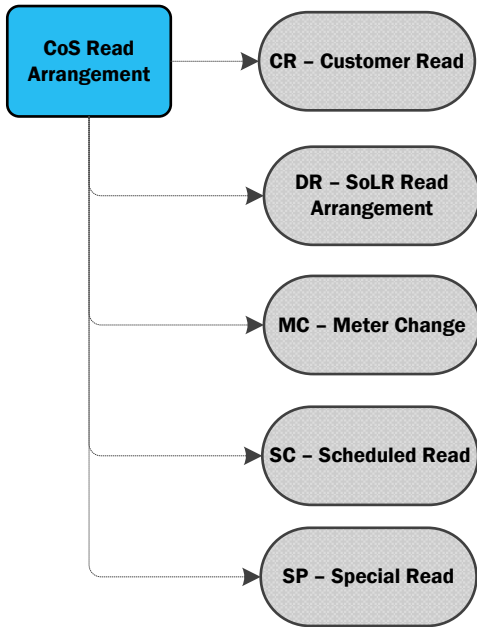

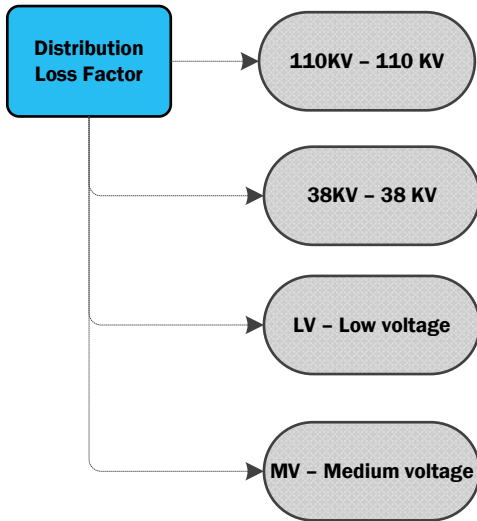

102P Change of Supplier Provisional Acceptance

Code

Meter Configuration Code

| | | | |
|-------------------|--------------------|-------------------|----------------------|
| MCC01 - 24 Hour | MCC10 - QH2CH_IP | MCC61 - 2x24h | MCC73 - 4x24H+NSH |
| MCC02 - P/N | MCC11 - QH4CH_IPXP | MCC62 - 2x24h+NSH | MCC74 - 5x24H |
| MCC03 - 24h+NSH | MCC50 - NONSTN | MCC63 - 2x24h+D | MCC75 - 24H+2xNSH |
| MCC04 - D/N+W | MCC51 - D/N+NSH | MCC64 - 2x24h+W | MCC76 - 4x24H+W |
| MCC05 - MDNm/PK | MCC53 - 2 X D/N | MCC65 - 3x24hr | MCC77 - 2x24H+W+NSH |
| MCC06 - MDNm+Pk | MCC57 - 24h+D | MCC67 - 3x24h+Day | MCC78 - 3x24H+W+NSH |
| MCC07 - 24H+NSH+W | MCC58 - 24h+D/N | MCC70 - 3x24H+NSH | MCC79 - 5x24H+NSH |
| MCC08 - 24h+W | MCC59 - 24h+D/N+W | MCC71 - 4x24H | MCC12 - HH1CH_1CR_IP |
| MCC09 - Unmetered | MCC60 - 24h+D/N+NS | MCC72 - 3x24H+W | MCC16 -SST IMP |

Message

MPRN Level Information

RMDS

RETAIL MARKET DESIGN SERVICE

Meter Configuration Code

102P Change of Supplier Provisional Acceptance

Code

Read Reason

- 01 - Scheduled
- 02 - Special Read, Chargeable
- 04 - Special Read to resolve dispute
- 09 - Special Read, non chargeable
- 10 - Ad-hoc, no chargeable check read
- 11 - Start reading after meter re-programming
- 13 - De-Energisation
- 14 - Estimate
- 16 - Closing read before meter re-programming
- 17 - Change of Profile
- 18 - Energisation
- 21 - Start Reading (New Register)
- 22 - Closing Reading (Register removed)
- 23 - Meter Works Single reading
- 26 - Change of Supplier
- 27 - Change of Legal Entity
- 28 - Closing read before register re-number
- 29 - Star read after register re-number
- 95 - Not for CoS

Message

MPRN Level Information

RMDS RETAIL MARKET DESIGN SERVICE

Read Reason

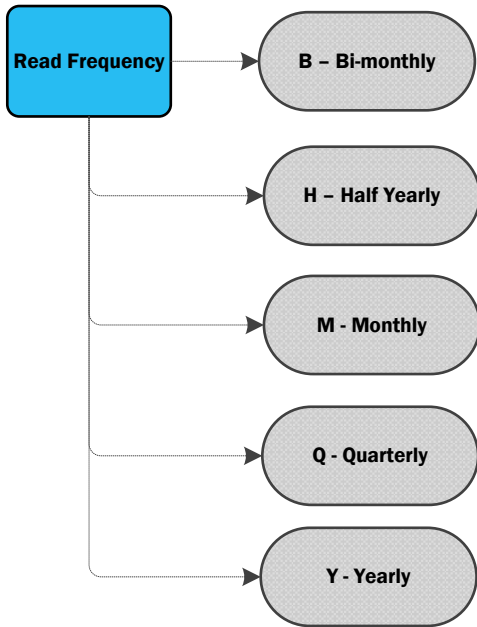

102P Change of Supplier Provisional Acceptance

Code

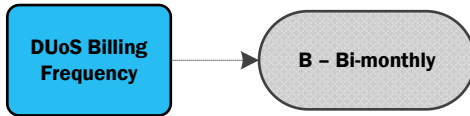

102P Change of Supplier Provisional Acceptance

Code

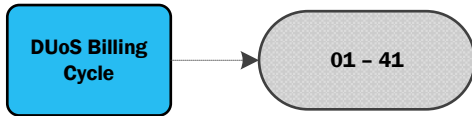

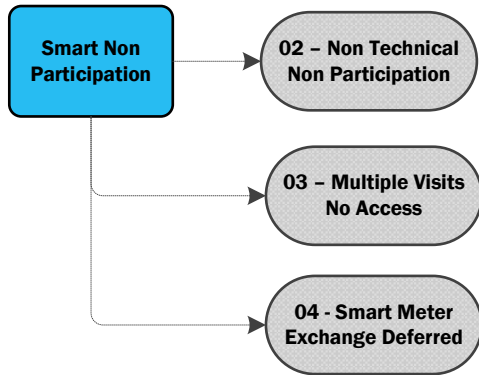

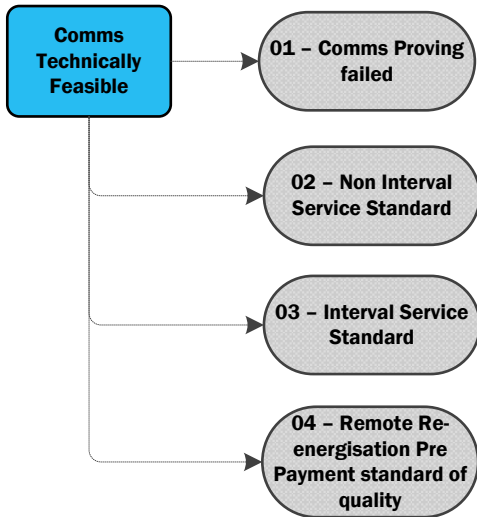

102P Change of Supplier Provisional Acceptance

Code

County
Ireland

| | | | | | | | |
|-----------|-----------|-----------|-------------|-----------|---------------------|-----------|-----------------|
| AM | Armagh | LK | Limerick | ZA | BHAILE ATHA CLIATHA | ZN | LIATROMA |
| AT | Antrim | LM | Leitrim | ZB | AN CHABHAIN | ZO | LOCH GARMAN |
| CE | Clare | LS | Laois | ZC | CHEATHARLACH | ZP | AN LONGFOIRT |
| CK | Cork | LY | Londonderry | ZD | CHIARRAI | ZQ | LU |
| CN | Cavan | MH | Meath | ZE | CHILL CHAINNIGH | ZR | LUIMNIGH |
| CW | Carlow | MN | Monaghan | ZF | CHILL DARA | ZS | MHAIGH EO |
| DB | Dublin | MO | Mayo | ZG | CHILL MHANTAIN | ZT | NA MI |
| DE | Derry | OY | Offaly | ZH | AN CHLAIR | ZU | MHUINEACHAIN |
| DL | Donegal | RN | Roscommon | ZI | CHORCAI | ZV | PHORT LAIRGE |
| DN | Down | SO | Sligo | ZJ | DHUN NA NGALL | ZW | ROS COMAIN |
| FM | Fermanagh | TP | Tipperary | ZK | NA GAILLIMHE | ZX | SHLIGIGH |
| GW | Galway | TY | Tyrone | ZL | NA HIARMHI | ZY | THIOBRAID ARANN |
| KE | Kildare | WD | Waterford | ZM | LAOISE | ZZ | UIBH FHAILI |
| KK | Kilkenny | WH | Westmeath | | | | |
| KY | Kerry | WW | Wicklow | | | | |
| LD | Longford | WX | Wexford | | | | |
| LH | Louth | | | | | | |

Message

Address

Meter Point
Address

RMDS

RETAIL MARKET DESIGN SERVICE

County Ireland

102P Change of Supplier Provisional Acceptance

Code

Country

| | | | | | | | | | | | | | |
|----|-----------------|----|-----------------|----|------------------|----|-----------------|----|-----------------|----|-----------------|----|-----------------|
| AD | Andorra | CA | Canada | FO | Faroe Islands | JM | Jamaica | MP | N.Mariana Islnd | PW | Palau | TO | Tonga |
| AE | UAE | CC | Coconut Islands | FR | France | JO | Jordan | MQ | Martinique | PY | Paraguay | TP | East Timor |
| AF | Afghanistan | CD | Congo | GA | Gabon | JP | Japan | MR | Mauretania | QA | Qatar | TR | Turkey |
| AG | Antigua/Barbuda | CF | Central Afr.Rep | GB | United Kingdom | KE | Kenya | MS | Montserrat | RE | Reunion | TT | Trinidad,Tobago |
| AI | Anguilla | CG | Congo | GD | Grenada | KG | Kyrgyzstan | MT | Malta | RO | Romania | TV | Tuvalu |
| AL | Albania | CH | Sw itzerland | GE | Georgia | KH | Cambodia | MU | Mauritius | RU | Russian Fed. | TW | Taiw an |
| AM | Armenia | CI | Ivory Coast | GF | French Guayana | KI | Kiribati | MV | Maldives | RW | Rw anda | TZ | Tanzania |
| AN | Dutch Antilles | CK | Cook Islands | GH | Ghana | KM | Comoros | MW | Malaw i | SA | Saudi Arabia | UA | Ukraine |
| AO | Angola | CL | Chile | GI | Gibraltar | KN | St Kitts&Nevis | MX | Mexico | SB | Solomon Islands | UG | Uganda |
| AQ | Antarctica | CM | Cameroon | GL | Greenland | KP | North Korea | MY | Malaysia | SC | Seychelles | UM | Minor Outl.Isl. |
| AR | Argentina | CN | China | GM | Gambia | KR | South Korea | MZ | Mozambique | SD | Sudan | US | USA |
| AS | Samoa, American | CO | Colombia | GN | Guinea | KW | Kuw ait | NA | Namibia | SE | Sw eden | UY | Uruguay |
| AT | Austria | CR | Costa Rica | GP | Guadeloupe | KY | Cayman Islands | NC | New Caledonia | SG | Singapore | UZ | Uzbekistan |
| AU | Australia | CU | Cuba | GQ | Equatorial Gui. | KZ | Kazakhstan | NE | Niger | SH | St. Helena | VA | Vatican City |
| AW | Aruba | CV | Cape Verde | GR | Greece | LA | Laos | NF | Norfolk Island | SI | Slovenia | VC | St. Vincent |
| AZ | Azerbaijan | CX | Christmas Islnd | GS | Sth Sandw ich Is | LB | Lebanon | NG | Nigeria | SJ | Svalbard | VE | Venezuela |
| BA | Bosnia-Herz. | CY | Cyprus | GT | Guatemala | LC | St. Lucia | NI | Nicaragua | SK | Slovakia | VG | Brit.Virgin Is. |
| BB | Barbados | CZ | Czech Republic | GU | Guam | LI | Liechtenstein | NL | Netherlands | SL | Sierra Leone | VI | Amer.Virgin Is. |
| BD | Bangladesh | DE | Germany | GW | Guinea-Bissau | LK | Sri Lanka | NO | Norw ay | SM | San Marino | VN | Vietnam |
| BE | Belgium | DJ | Djibouti | GY | Guyana | LR | Liberia | NP | Nepal | SN | Senegal | VU | Vanuatu |
| BF | Burkina-Faso | DK | Denmark | HK | Hong Kong | LS | Lesotho | NR | Nauru | SO | Somalia | WF | Wallis, Futuna |
| BG | Bulgaria | DM | Dominica | HM | Heard/McDon.Isl | LT | Lithuania | NU | Niue Islands | SR | Suriname | WS | Western Samoa |
| BH | Bahrain | DO | Dominican Rep. | HN | Honduras | LU | Luxembourg | NZ | New Zealand | ST | S.Tome,Principe | YE | Yemen |
| BI | Burundi | DZ | Algeria | HR | Croatia | LV | Latvia | OM | Oman | SV | El Salvador | YT | Mayotte |
| BJ | Benin | EC | Ecuador | HT | Haiti | LY | Libya | PA | Panama | SY | Syria | YU | Yugoslavia |
| BM | Bermuda | EE | Estonia | HU | Hungary | MA | Morocco | PE | Peru | SZ | Sw aziland | ZA | South Africa |
| BN | Brunei | EG | Egypt | ID | Indonesia | MC | Monaco | PF | Frenc.Polynesia | TC | Turksh Caicosin | ZM | Zambia |
| BO | Bolivia | EH | West Sahara | IE | Ireland | MD | Moldavia | PG | Pap. New Guinea | TD | Chad | ZW | Zimbabw e |
| BR | Brazil | ER | Eritrea | IL | Israel | MG | Madagascar | PH | Philippines | TF | French S.Territ | | |
| BS | Bahamas | ES | Spain | IN | India | MH | Marshall Islnds | PK | Pakistan | TG | Togo | | |
| BT | Bhutan | ET | Ethiopia | IO | Brit.Ind.Oc.Ter | MK | Macedonia | PL | Poland | TH | Thailand | | |
| BV | Bouvet Island | FI | Finland | IQ | Iraq | ML | Mali | PM | St.Pier,Miquel. | TJ | Tajikstan | | |
| BW | Botsw ana | FJ | Fiji | IR | Iran | MM | Myanmar | PN | Pitcairn Islnds | TK | Tokelau Islands | | |
| BY | Belarus | FK | Falkland Islnds | IS | Iceland | MN | Mongolia | PR | Puerto Rico | TM | Turkmenistan | | |
| BZ | Belize | FM | Micronesia | IT | Italy | MO | Macau | PT | Portugal | TN | Tunisia | | |

Message

Address

Meter Point
Address

Post Box

RMDS

RETAIL MARKET DESIGN SERVICE

Country

102P Change of Supplier Provisional Acceptance

Code

Title

Br - Brother

Msgr - Monsignor

Cllr - Councillor

Ms - Ms

Dr - Doctor

Prof - Professor

Fr - Father

Rec - Reverend

Lady - Lady

Sir - Sir

Lord - Lord

Sr - Sister

Miss - Miss

Mr - Mr

Mrs - Mrs

Message

Customer Name

RMDS RETAIL MARKET DESIGN SERVICE

Title

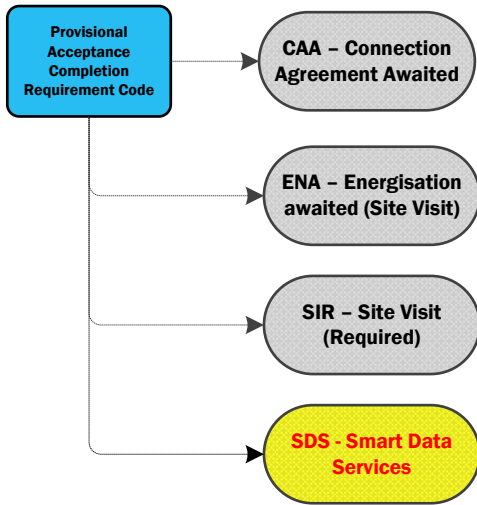

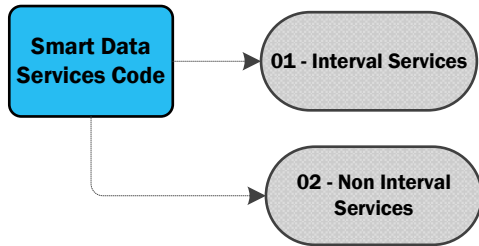

102P Change of Supplier Provisional Acceptance

| Version Which Implemented | Source of Change | Description of Change |
|---------------------------|------------------|--|
| 10.4 | MCR 1155 | Message format changed from ARIS to Document format. |
| 11.0 | MCR 1122 | New Data Item Essential Plant Flag added |
| 13.0 | MCR1159 | New Data items added in to MPRN Level Information, New Codes added for Load Profile, Meter Configuration Code (Required), Meter Configuration Code, DUoS Billing Frequency, DuOS Billing Cycle, Smart Non Participation, Comms Technical Feasible & Smart Data Services. |